

# 4W GU10 RGB+CCT LED Spotlight

2.4GHz Remote control & APP control, Support Third Party Voice Control, 16 million colors to choose, adjustable brightness, color temperature and saturation, Signal transmitting & Modes synchronization.



## Product Parameters

- Product Name: 4W GU10 RGB+CCT LED Spotlight
- Model No: FUT103
- Power: 4W
- Voltage: AC100-240V 50/60Hz
- Color Temperature: 2700K-6500K
- Luminous Flux: 280LM
- Luminous Efficiency: 70LM/W
- CRI: >80
- PF: >0.55
- Lifespan: 50000h
- Base Type: GU10
- Beam Angle: 25°
- RF: 2.4GHz
- Control Distance: 30m

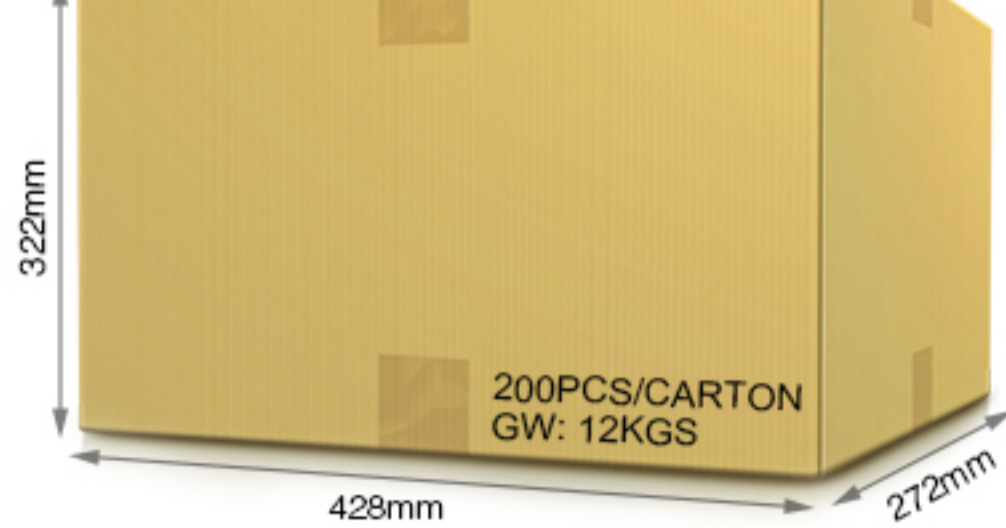
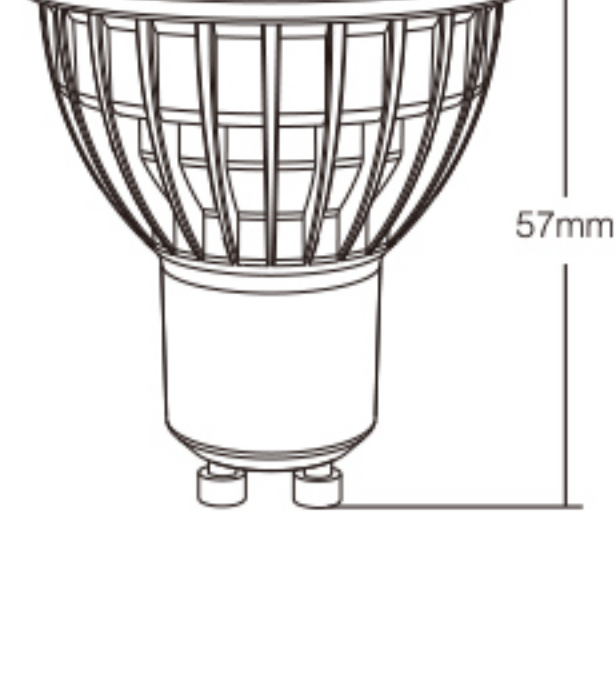

## 2.4GHz RF Remote controllable

Compatible with

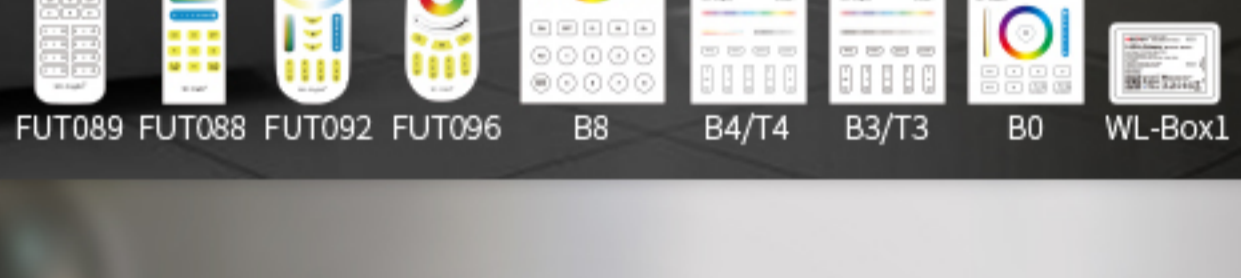

## Support Smart phone APP control and third party voice control

It need 2.4GHz gateway(WL-Box1) for smart phone control or third party voice control

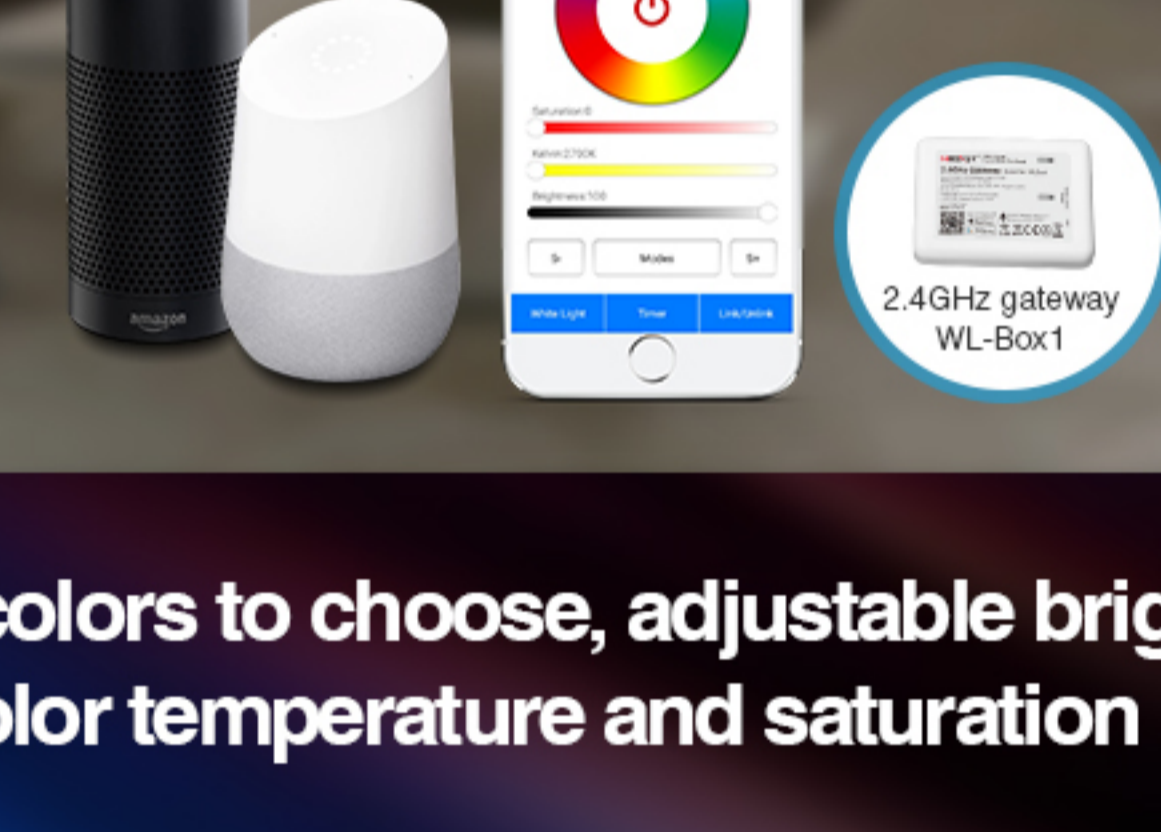

## 16 million colors to choose, adjustable brightness, color temperature and saturation

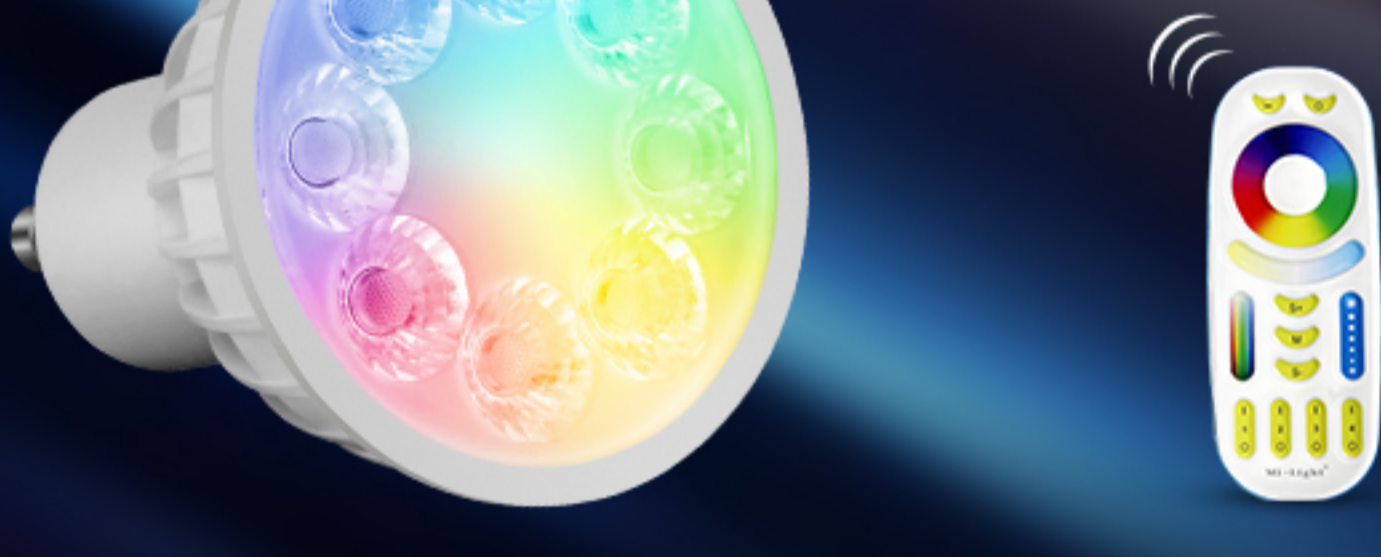

## Signal transmitting

One lighting fixture can transmit the signals from the remote control to another lighting fixture within 30m, as long as there is a lighting fixture within 30m, the remote control distance can be limitless.

## Modes synchronization

Different lighting fixture can work synchronously when they are started at different times, controlled by the same remote, under same dynamic mode and within 30m distance.

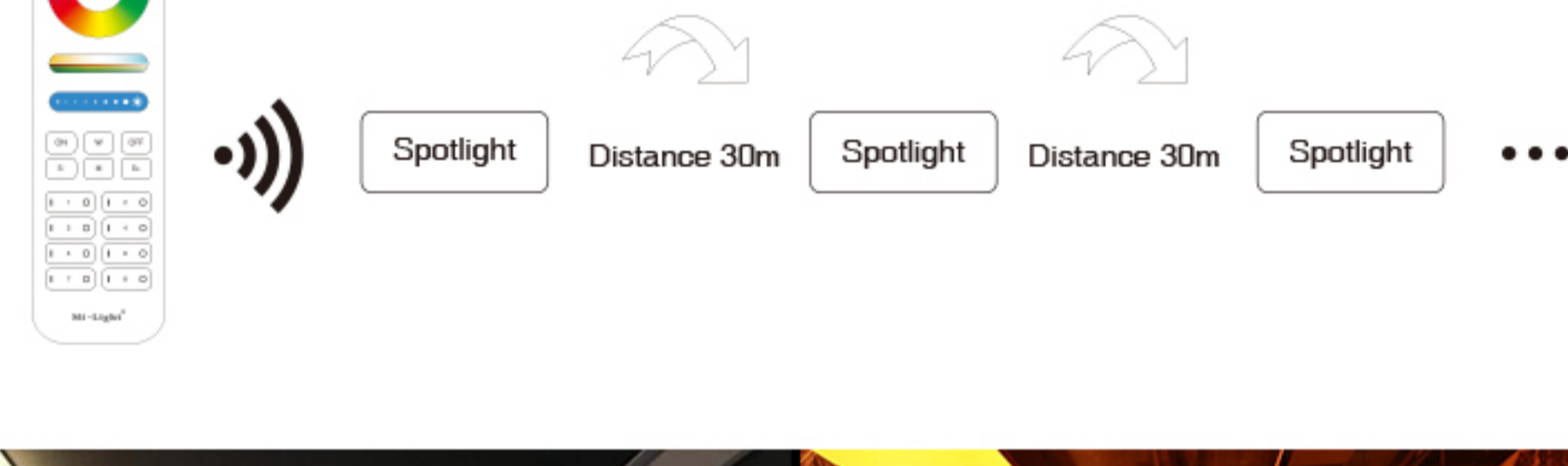

### Acrylic Transmitting Cover

Using imported PC pervious to light cover, light transmittance over 90%

### Lamp Body

Flame retardant material, long-term heat resistance

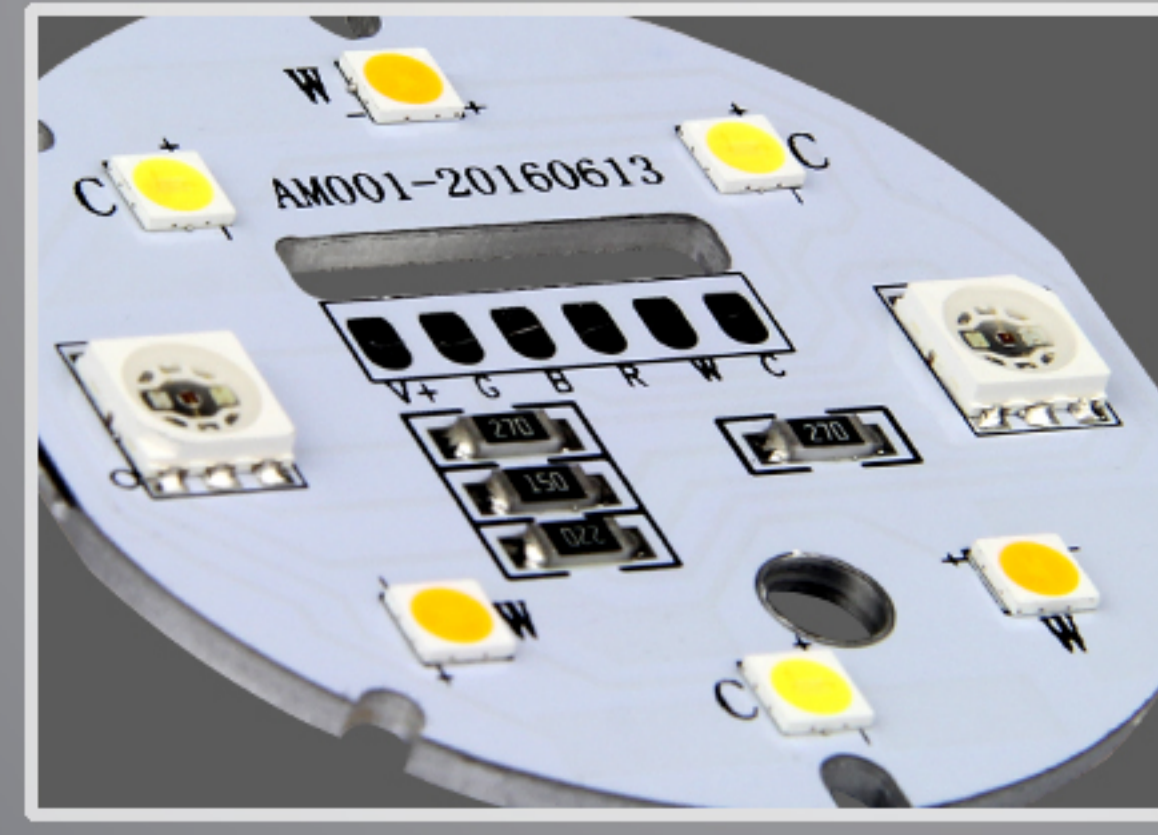

### High Grade LED

Taiwan's high quality lamp bead, service life of up to 50000 hours

### Reliable Power Driver

With constant current constant voltage 4W power, 100-240V wide working voltage, work safer and more stable

