

GRUPPO  RAINA
Lookup

GRUPPO RAINA
L'unione fa la luce.

IDEALLUX®

Lookup

COLOMBO

ITALIANARETAIL





IDEALLUX

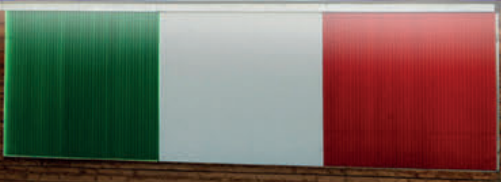

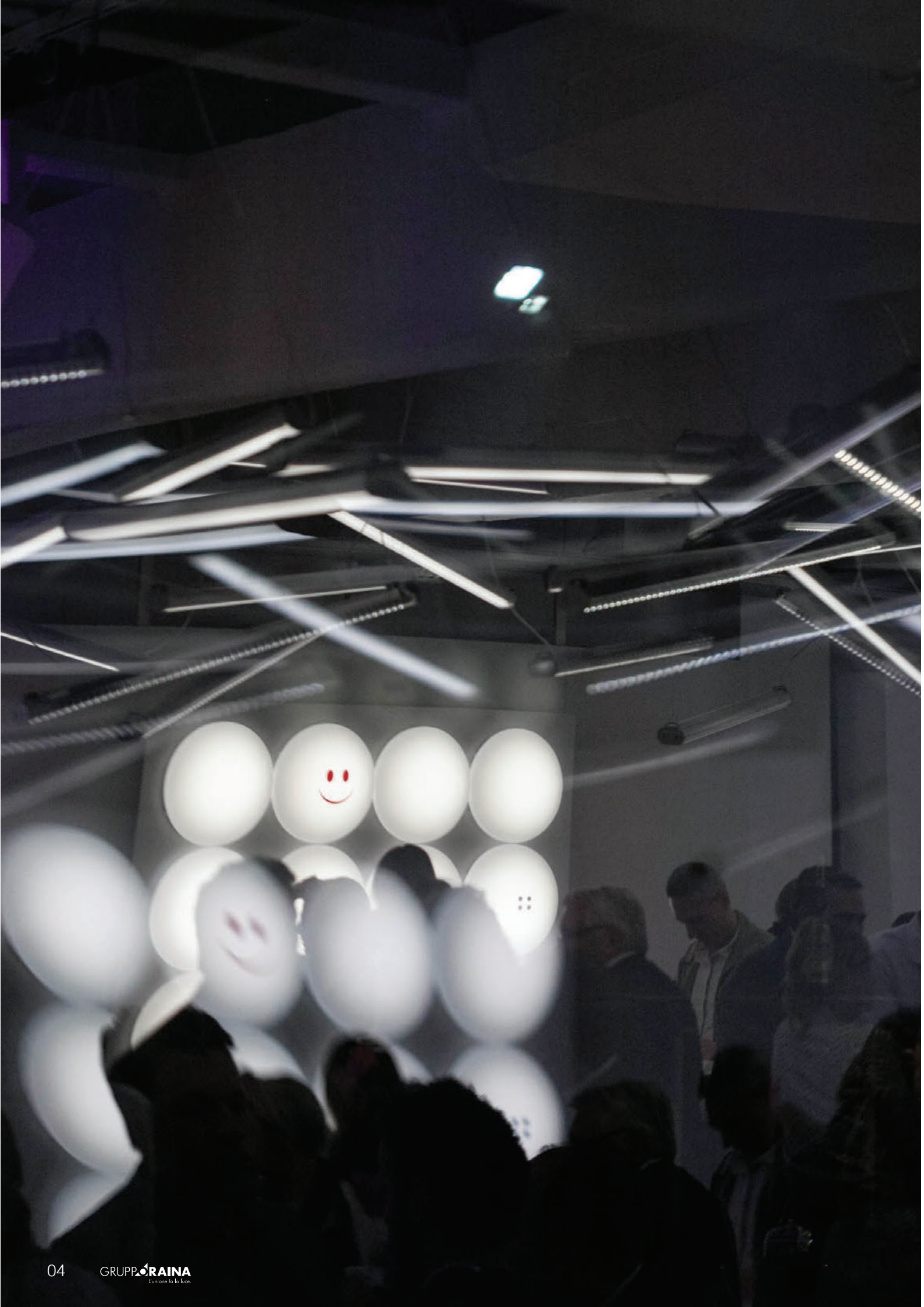

INDEX

GENERAL INDEX

06-07	Illustrated Index (Suspension, Wall, Floor, Table Lamp)
09	Mission
11	Quality
13	Company History
15	Magnetic Cover
17	Colour Selection
18-119	Suspension
120-203	Wall
204-233	Floor
234-259	Table Lamp
260-261	Legenda (How to read the catalogue - Product characteristics table)
262-265	Legenda (Possible applications - Symbols of the technical details)
266-267	Analytical products and accessoires index
268	Connection scheme
269-271	General sales conditions

PRODUCT INDEX

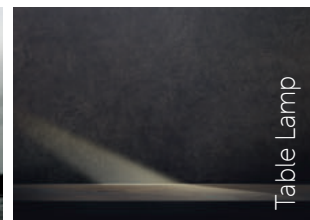
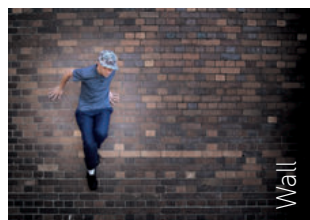
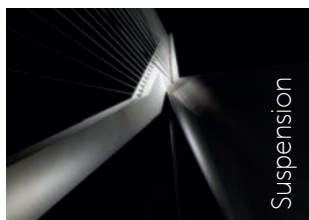

Product	Page	Section
Adalpina	108-111	Suspension
Alba	140-143	Wall
Amadeus	214-217	Floor
Aquadro	86-89	Suspension
Arrondo	58-63	Suspension
Bombei m	200-203	Wall
Calea	152-155	Wall
Circo	78-81	Suspension
Dosi	176-179	Wall
Dudu	172-175	Wall
Eliot	90-93	Suspension
Ester	168-171	Wall
Faces m	148-151	Wall
Furba	230-233	Floor
Gina	180-183	Wall
Jeè	98-101	Suspension
Libra	112-115	Suspension
Lina	244-247	Table Lamp

Product	Page	Section
Mali	184-187	Wall
Nori	94-97	Suspension
Norton	188-191	Wall
Olimpia	82-85	Suspension
Opalia	116-119	Suspension
Pla	196-199	Wall
Round	64-73	Suspension
Sphere	248-251	Table Lamp
Silence	218-221	Floor
SOO ad	26-29	Suspension
SOO ai	30-33	Suspension
SOO c	236-239	Table Lamp
SOO e	46-51	Suspension
SOO l	34-39	Suspension
SOO m	126-131	Wall
SOO pd	206-213	Floor
SOO r	52-57	Suspension
SOO pi	132-135	Wall

Product	Page	Section
SOO s	40-45	Suspension
SOO t	240-243	Table Lamp
SOO upd	122-125	Wall
SOO v	20-25	Suspension
SOO w	136-139	Wall
Squadra	252-255	Table Lamp
Squak	102-107	Suspension
Stilo	256-259	Table Lamp
Talè	162-167	Wall
Tink	144-147	Wall
Trem	192-195	Wall
Ufo	74-77	Suspension
Utile	222-225	Floor
Zero	226-229	Floor
Zoe	156-161	Wall

INDEX

ILLUSTRATED INDEX

SUSPENSION



SOO vd
p. 22-23



SOO vi
p. 24-25



SOO ad
p. 28-29



SOO ai
p. 32-33



SOO ld
p. 36-37



SOO li
p. 38-39



SOO sd
p. 42-43



SOO si
p. 44-45



SOO ee
p. 48-49



SOO ei
p. 50-51



SOO re
p. 54-55



SOO ri
p. 56-57



Arrondo d
p. 60-61



Arrondo di
p. 62-63



Round d
p. 66-67



Round di
p. 68-69



Round IP55
p. 72-73



Ufo
p. 76-77



Circo
p. 80-81



Olimpia
p. 84-85



Aquadro
p. 88-89



Eliot
p. 92-93



Nori
p. 96-97



Jeè
p. 100-101



Squak d
p. 104-105



Squak di
p. 106-107



Adalpina
p. 110-111



Libra
p. 114-115



Opalia
p. 118-119

INDEX

ILLUSTRATED INDEX

WALL



SOO upd
p. 124-125



SOO md
p. 128-129



SOO mi
p. 130-131



SOO pi
p. 134-135



SOO wi
p. 138-139



Alba
p. 142-143



Tink
p. 146-147



Faces m
p. 150-151



Calea
p. 154-155



Zoe m - Zoe
p. 158-161



Talè m - Talè
p. 164-167



Ester
p. 170-171



Dudu
p. 174-175



Dosi
p. 178-179



Gina
p. 182-183



Mali
p. 186-187



Norton
p. 190-191



Trem
p. 194-195



Pla
p. 198-199



Bombei m
p. 202-203

FLOOR



SOO pd
p. 208-209



SOO pdi
p. 212-213



Amadeus
p. 216-217



Silence
p. 220-221



Utile
p. 224-225

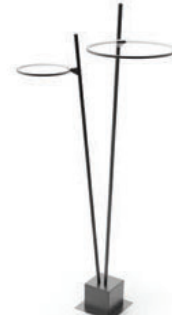

Zero
p. 228-229



Furba
p. 232-233

TABLE LAMP



SOO c
p. 238-239



SOO t
p. 242-243



Lina
p. 246-247



Sphere
p. 250-251



Squadra
p. 254-255



Stilo
p. 258-259



MISSION

The group's mission is the design and production of lighting systems characterized from high technology and very good performance, totally made at the Cilavegna plant in the Province of Pavia and certified 100% Made in Italy. The Gruppo Raina obtained the Certification ISO 9001: 2008 and the 100% Made in Italy Certification issued by the International Institute for the Protection of Italian Manufacturers. The numbers of the group can explain the capacity of it: 12.000 square meters of production plant, 7.000 sqm of warehouse, 100 resources employed and more than 3.800 active customers.



IT MISSION

Il gruppo ha come mission la progettazione e la produzione di sistemi di illuminazione, caratterizzati da un'elevata tecnologia e da un ottimo rendimento, totalmente realizzati nello stabilimento di Cilavegna, in Provincia di Pavia e certificati 100% Made in Italy. Gruppo Raina vanta tra le certificazioni ottenute la certificazione ISO 9001:2008 e la certificazione 100% Made in Italy rilasciata dall'Istituto per la Tutela dei Produttori Italiani. I numeri del gruppo riassumono le capacità dello stesso, con i suoi 12.000 mq di stabilimento produttivo, 7.000 mq di magazzino, 100 risorse impiegate e oltre 3.800 clienti attivi.

FR MISSION

Le groupe a pour mission la conception et la production de systèmes d'éclairage à haut niveau technologique et hautes performances, le tout est réalisé dans l'usine de Cilavegna, en province de Pavia. La certification ISO 9001 et la certification 100% Made in Italy ont été délivrées par l'Institut de Protection des Fabricants Italiens. En chiffres : 12.000 m² production, 7.000 m² stockage, 100 employés et 3.800 clients actifs.

ES MISSION

El grupo tiene como misión el diseño y producción de sistemas de iluminación, fabricados en la p CERTIFICACIONES. La certificación ISO 9001: 2008 Certificación 100% Made in Italy emitida por el instituto para la Protección de Fabricantes Italianos lanta de Cilavegna, en la Provincia de Pavia y certificados 100% Made in Italy. LOS NUMEROS: 12.000 mq de planta de producción, 7.000 mq de almacén, 100 recursos utilizados, 3.800 clientes activos.

DE MISSION

Die Gruppe hat sich zum Ziel gesetzt, Beleuchtungssysteme zu entwerfen und zu produzieren, die sich durch Hochtechnologie und hervorragende Leistung auszeichnen. Sie werden vollständig im Werk von Cilavegna in der Provinz Pavia hergestellt und sind zu 100% Made in Italy zertifiziert. Die Gruppo Raina hat unter den Zertifizierungen die ISO 9001: 2008-Zertifizierung und die 100% Made in Italy-Zertifizierung des Instituts zum Schutz italienischer Hersteller erhalten. Die Zahlen der Gruppe fassen die Kapazität derselben mit 12.000 Quadratmetern Produktionsanlage, 7.000 Quadratmetern Lagerhalle, 100 Mitarbeitern und mehr als 3.800 aktiven Kunden zusammen.



QUALITY

With a view to customer satisfaction and service optimization, Ideallux® has put in place quality control processes with the aim of limiting defectiveness, which has been less than 1% (ISO statistical data of the last three years).

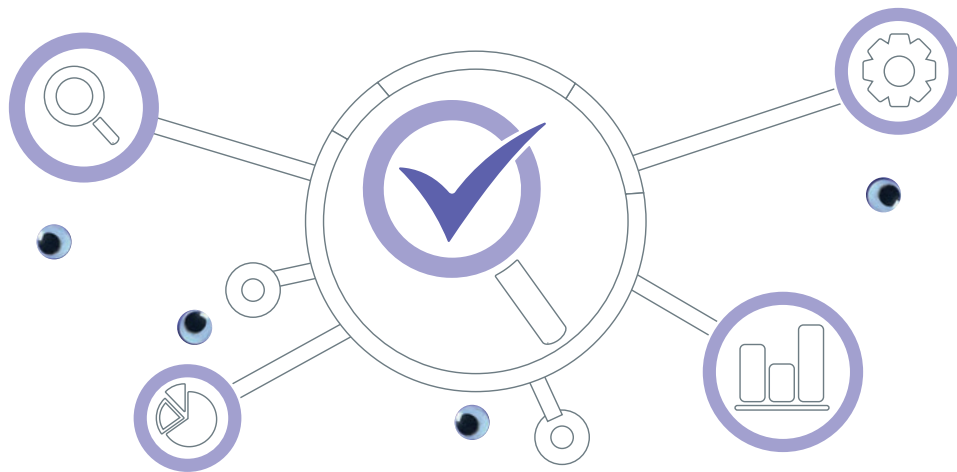

IT

QUALITÀ

Nell'ottica della soddisfazione del cliente e dell'ottimizzazione del servizio, Ideallux® ha messo in atto processi di controllo qualità con l'obiettivo di limitare la difettosità, che si è attestata ad una percentuale inferiore all'1% (dato statistico ISO degli ultimi tre anni).

FR

QUALITÉ

Dans l'optique de la satisfaction du client et de l'optimisation du service, Ideallux® a mis en place d'un processus de contrôle qualité avec l'objectif de limiter les défauts ces derniers ne dépassant pas 1 % (info statistique ISO calculée sur les trois dernières années).

ES

CALIDAD

Con miras a la satisfacción del cliente y la optimización del servicio, Ideallux® ha puesto en marcha procesos de control de calidad con el objetivo de limitar la defectuosidad, que ha alcanzado un porcentaje inferior al 1% (datos estadísticos ISO de los últimos tres años).

DE

QUALITÄT

Im Hinblick auf Kundenzufriedenheit und Serviceoptimierung hat Ideallux® Qualitätskontrollprozesse eingeführt, um den Fehler zu begrenzen, der einen Prozentsatz von weniger als 1% erreicht hat (ISO-Statistikdaten der letzten drei Jahre).



COMPANY HISTORY

1987 › Ideallux® was founded in 1987 by the will of Claudio Raina. Born as an artisan company producing lighting equipment, to become in a few years one of the most important producers in the lighting sector.

2011 › In 2011 the transition from traditional sources takes place, while LED technology is being developed. Ideallux® launches a catalog exclusively dedicated to LED lighting fixtures, alongside the well-established fluorescence product catalogue.

2017 › 2017 marked the milestone of 30 years of activity. The Fuorisalone 2017 - Via Tortona - Milan was the perfect location to celebrate this important stage, presenting the Ideallux® products with a new look.

2018 › In 2018 on the occasion of Light + Building in Frankfurt, the most prestigious lighting fair on the international scene, Ideallux® presents the new Gruppo Raina to the lighting world. Gruppo Raina is the brand that brings together the Ideallux®, Lookup and Colombo brands under the same name.

2021 › In 2018 on the occasion of Light + Building in Frankfurt, the most prestigious lighting fair on the international scene, Ideallux® presents the new Gruppo Raina to the lighting world. Gruppo Raina is the brand that brings together the Ideallux®, Lookup and Colombo brands under the same name.

2022 › Gruppo Raina expands its product range. The new ITALIANA RETAIL brand is born and the related catalog is released entirely dedicated to the CONTRACT & RETAIL sector.

IT

LA STORIA

Ideallux® viene fondata nel 1987 per volontà di Claudio Raina. Nasce come azienda artigiana di produzione di apparecchi di illuminazione, per divenire in pochi anni un'importante realtà industriale del settore di illuminazione. Nel 2011 avviene il passaggio dalle fonti tradizionali alle nuove tecnologie LED. Ideallux® lancia un catalogo dedicato esclusivamente ad apparecchi di illuminazione LED, affiancandolo all'ormai consolidato catalogo di prodotti fluorescenza. Il 2017 ha segnato il traguardo dei 30 ANNI di attività. Il Fuorisalone 2017 - Via Tortona - Milano è stata la location perfetta per festeggiare questa importantissima tappa, presentando i prodotti Ideallux® con una nuova veste. Nel 2018, in occasione di Light+Building, la più prestigiosa fiera dell'illuminazione nel panorama internazionale, Ideallux® presenta al mondo del lighting il nuovo Gruppo Raina. Gruppo Raina è il brand che raggruppa sotto lo stesso nome i marchi Ideallux®, Lookup e Colombo. Gruppo Raina amplia la sua gamma di prodotti. Nasce il nuovo brand ITALIANA RETAIL e il relativo catalogo interamente dedicato al settore CONTRACT & RETAIL.

FR

HISTOIRE

Ideallux® a été fondée en 1987 par Claudio Raina. A l'origine comme usine artisanale de production des appareils d'éclairage, reconnue quelques années après comme une importante réalité industrielle dans le secteur de l'éclairage. En 2011 surgit le passage des sources traditionnelles aux nouvelles technologies LED. Ideallux® édite un catalogue exclusivement consacré aux appareils d'éclairage LED, en coexistence avec le catalogue de la gamme fluorescence. En 2017 l'usine fête ses 30 ANS d'activité. Le Salon international Fuorisalone 2017 à Milan fut l'occasion et l'endroit parfait pour célébrer cette importante étape en présentant les produits Ideallux® sous une nouvelle veste. En 2018, à l'occasion du Salon International Light&Building, le plus prestigieux concernant l'éclairage dans le panorama international, Ideallux® présente au monde du Lighting le nouveau Gruppo Raina. Gruppo Raina regroupe sous le même nom les marques Ideallux®, Lookup et Colombo. Gruppo Raina étend sa gamme de produits. La nouvelle gamme ITALIANA RETAIL voit le jour ainsi que le catalogue entièrement consacré au secteur CONTRACT & RETAIL.

ES

HISTORIA

Ideallux® fue fundada en 1987 por voluntad de Claudio Raina. Nace como una empresa artesanal que produce aparatos de iluminación, para convertirse en pocos años en una realidad industrial importante en el sector de la iluminación. En 2011 se lleva a cabo la transición de las fuentes tradicionales de iluminación a las nuevas tecnologías LED. Ideallux® lanza un catálogo dedicado exclusivamente a los aparatos de iluminación LED, uniéndolo con el ya bien consolidado catálogo de productos de fluorescencia. 2017 marcó el hito de 30 años de actividad. El Fuorisalone 2017 - Via Tortona - Milán fue el lugar perfecto para celebrar esta importantísima etapa, presentando los productos Ideallux® con un nuevo look. En 2018, con motivo de Light + Building, la feria de iluminación más prestigiosa de la escena internacional, Ideallux® presenta el nuevo Gruppo Raina al mundo de la iluminación. Gruppo Raina es la marca que agrupa a las marcas Ideallux®, Lookup y Colombo bajo el mismo nombre. Gruppo Raina amplía su gama de productos. Nace la nueva marca ITALIANA RETAIL y su catálogo totalmente dedicado al sector CONTRACT & RETAIL.

DE

DIE GESCHICHTE

Geboren als handwerkliches Unternehmen, das Beleuchtungsgeräte herstellt, um in wenigen Jahren eine wichtige industrielle Realität in der Beleuchtungsbranche zu werden. Im Jahr 2011 findet der Übergang von traditionellen Quellen zu neuen LED-Technologien statt. Neben dem bekannten Fluoreszenz-Produktkatalog führt Ideallux® einen Katalog ein, der sich ausschließlich mit LED-Beleuchtungsgeräten befasst. 2017 war der Meilenstein von 30 Jahren Aktivität. Die Fuorisalone 2017 - Via Tortona - Mailand war der perfekte Ort, um diese wichtige Etappe zu feiern und die Ideallux® Produkte mit einem neuen Look zu präsentieren. Im Jahr 2018 präsentiert Ideallux® anlässlich der Light + Building, der prestigeträchtigsten Lichtmesse der internationalen Szene, die neue Raina Group der Lichtwelt. Gruppo Raina ist die Marke, die die Marken Ideallux®, Lookup und Colombo unter demselben Namen vereint. Gruppo Raina erweitert ihre Produktpalette. Die neue Marke ITALIANA RETAIL wird geboren und der zugehörige Katalog wird herausgegeben, der ausschließlich dem Sektor CONTRACT & RETAIL gewidmet ist.



MAGNETIC COVER

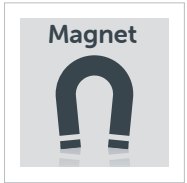

DO YOU WANT TO CHANGE THE LOOK OF YOUR ROOM TODAY? ...

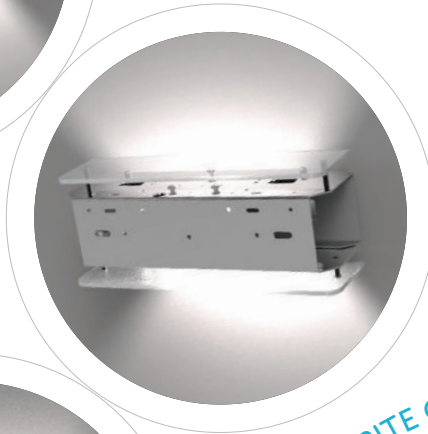

CHOOSE YOUR FAVOURITE COLOUR AND CHANGE THE COVER WHENEVER YOU WANT!



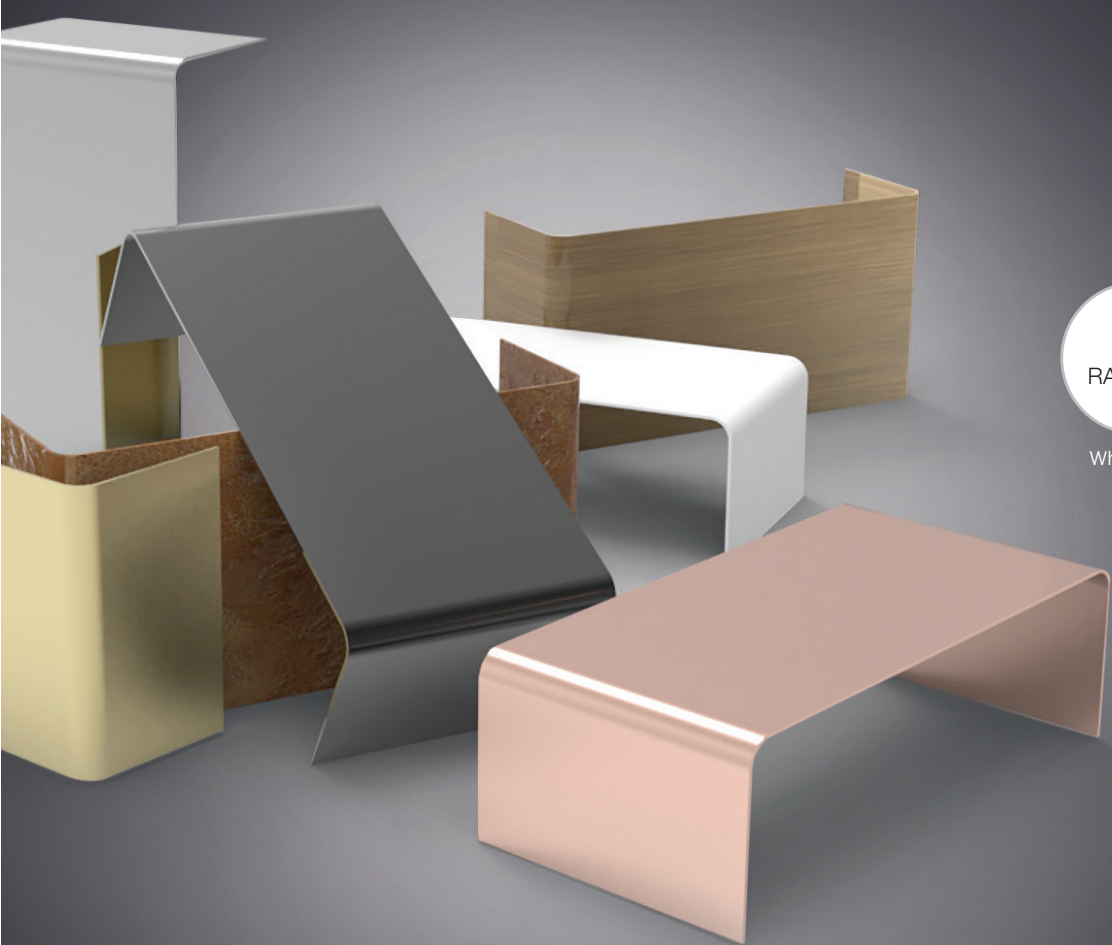

WI
RAL 9016

White Irazu

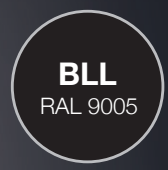

BLL
RAL 9005

Black Lava

..... STANDARD

COLOUR SELECTION



Silver Bombalai



Bronze Lario



Rust Rame

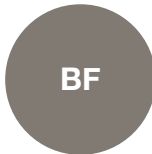

Beige Futura



Gold Karkar

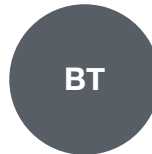

Blue Telica

..... ON REQUEST
.....







Suspension





SOOS V



SOO vd



Decorative suspension lighting fitting

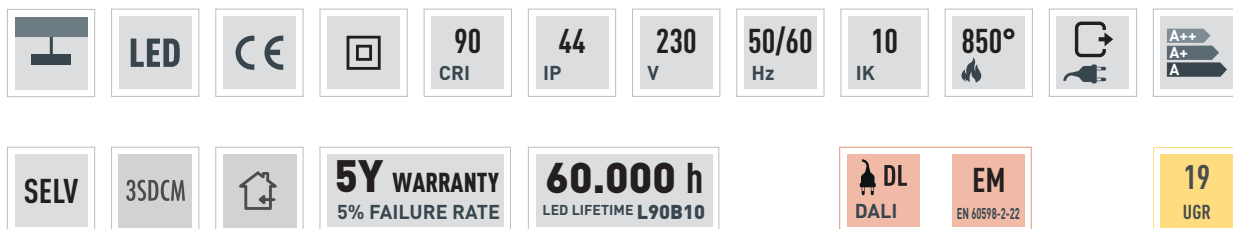

On request

Only for cod. MP

IT

Apparecchio decorativo per installazione a sospensione. Corpo ultrapiatto in estruso di alluminio calandrato. Sorgente luminosa LED diretta. Verniciatura con polveri epossidiche antigraffio. Diffusore in policarbonato opale (cod. OP), microprismato UGR 19 (cod. MP). Fornito completo di sospensioni in acciaio regolabili e cavo di alimentazione L=2m. Alimentatore incluso esterno. Rosone per collegamento elettrico non incluso, da ordinare separatamente.

ES

Luminaria decorativa de suspensión. Cuerpo ultraplano de aluminio extruido calandrado. Fuente de iluminación LED directa. Barnizado con polvo epoxi anti-rayado. Difusor de policarbonato opal (código OP), microprismato UGR19 (código MP). Cables de suspensión de acero ajustables y cable de alimentación L=2m incluidos. Balasto externo incluido. Roseta electrificada no incluida, a pedir por separada.

EN

Decorative suspension lighting fitting. Extruded linear aluminum ultra-flat body. Direct LED light source. Painted with scratch-resistant epoxy powders. Opal polycarbonate diffuser (code OP), microprismatic UGR 19 (code MP). Supplied complete with adjustable steel suspensions and power cable L = 2m. External driver included. Rose ceiling for electrical connection not included, to be ordered separately.

DE

Dekoratives Hängebeleuchtungsgerät. Ultraflacher Körper aus extrudiertem, kalandriertem Aluminium. Direkte LED-Lichtquelle. Lackiert mit kratzfesten Epoxidpulvern. Diffusor aus opalem Polycarbonat (Kode OP), mikroprismatisch UGR 19 (Kode MP). Komplett mit verstellbaren Stahlhängungen und Netzkabel L = 2m. Externer elektronischer Treiber enthalten. Deckenbefestigung für elektrische Verbindung nicht enthalten, separat zu bestellen.

FR

Appareil décoratif en suspension. Corps extra plat en aluminium extrudé linéaire. Source lumineuse LED directe. Finition de peinture en poudre époxy anti-rayures. Diffuseur en polycarbonate opal (réf. OP), microprismé UGR 19 (réf. MP). Fourni avec fils de suspensions en acier réglables et câble d'alimentation L= 2mt. Driver externe inclus. Patère et branchement électrique exclus, à commander séparément.

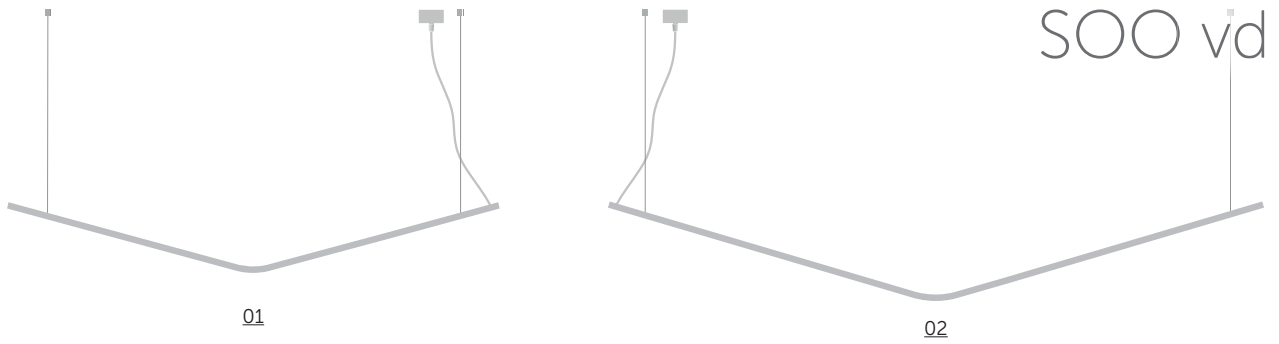

SOO vd 4000 K

Code	Diffuser	Size	Lumen Out*	Watt Tot	K	Beam angle	Driver Type	Driver Nr.	Colour
YSVD16N	OP: Opal	01	5780	68	4000	D	ON/OFF	1	○
YSVD15N		01	2890	34	4000	D	ON/OFF	1	○
YSVD21N	MP: Microprismatic	02	7650	90	4000	D	ON/OFF	1	○
YSVD20N		02	3825	45	4000	D	ON/OFF	1	○

SOO vd 3000 K

Code	Diffuser	Size	Lumen Out*	Watt Tot	K	Beam angle	Driver Type	Driver Nr.	Colour
YSVD16W	OP: Opal	01	5320	68	3000	D	ON/OFF	1	○
YSVD15W		01	2660	34	3000	D	ON/OFF	1	○
YSVD21W	MP: Microprismatic	02	7040	90	3000	D	ON/OFF	1	○
YSVD20W		02	3520	45	3000	D	ON/OFF	1	○

*Output flux with opal diffuser. With microprismatic diffuser + 10%

SOO vd STANDARD COLOUR SELECTION

● **WI** | White Irazu ● **BLL** | Black Lava

SOO vd ON REQUEST COLOUR SELECTION

● **BF** | Beige Futuna ● **SB** | Silver Bombalai ● **GK** | Gold Karkar
 ● **BL** | Bronze Lario ● **RR** | Rust Rame ● **BT** | Blue Telica

SOO vd BEAM ANGLE | DIMENSIONS

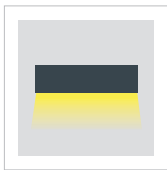

Size	X [mm]	Y [mm]	Z [mm]	Kg
01	1500	200	50	1,5
02	2000	300	50	1,9

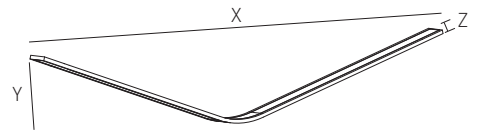

Min and Max room temperature: -20°+45° C.

SOO ACCESSORIES

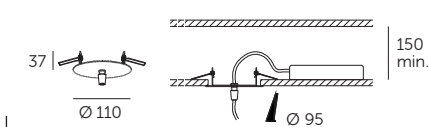

YKT10301 + ○ COLOUR

Rose ceiling for installation with ceiling panel, remote driver.

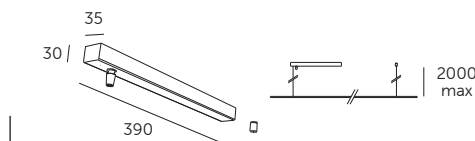

YKT10401 + ○ COLOUR

Rose ceiling for brick installation with driver housing.

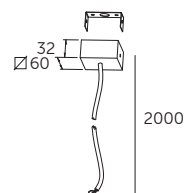

YKT10501 + ○ COLOUR

Rose ceiling for brick installation without driver housing. For remote driver 24 Volt max 5 mt.

SOO vi



Decorative suspension lighting fitting



On request

IT

Apparecchio decorativo per installazione a sospensione. Corpo ultrapiatto in estruso di alluminio calandrato. Sorgente luminosa LED indiretta. Verniciatura con polveri epossidiche antigraffio. Diffusore in policarbonato opale (cod. OP), microprismato UGR 19 (cod. MP) Fornito completo di sospensioni in acciaio regolabili e cavo di alimentazione L=2m. Alimentatore incluso esterno. Rosone con collegamento elettrico non incluso, da ordinare separatamente.

ES

Luminaria decorativa de suspensión. Cuerpo ultraplano de aluminio extruido calandrado. Fuente de iluminación LED indirecta. Barnizado con polvo epoxi anti-rayado. Difusor de policarbonato opal (código OP), microprismato UGR19 (código MP). Cables de suspensión de acero ajustables y cable de alimentación L=2m incluidos. Balasto externo incluido. Roseta electrificada no incluida, a pedir por separada.

EN

Decorative suspension lighting fitting. Extruded calendered aluminum ultra-flat body. Indirect LED light source. Painted with scratch-resistant epoxy powders. Opal polycarbonate diffuser (code OP), microprismatic UGR 19 (code MP). Supplied complete with adjustable steel suspensions and power cable L = 2m. External driver included. Rose ceiling for electrical connection not included, to be ordered separately.

DE

Dekoratives Hängebeleuchtungsgerät. Ultraflacher Körper aus extrudiertem, kalandriertem Aluminium. Indirekte LED-Lichtquelle. Lackiert mit kratzfesten Epoxidpulvern. Diffusor aus opalem Polycarbonat (Kode OP), mikroprismatisch UGR 19 (Kode MP). Komplett mit verstellbaren Stahlabhängungen und Netzkabel L = 2m. Externer elektronischer Treiber enthalten. Deckenbefestigung für elektrische Verbindung nicht enthalten, separat zu bestellen.

FR

Appareil décoratif en suspension. Corps extra plat en aluminium extrudé courbé Source lumineuse LED indirecte Finition de peinture en poudre époxy anti-rayures. Diffuseur en polycarbonate opal (réf. OP), microprismé UGR 19 (réf. MP) Fourni avec fils de suspensions en acier réglables et câble d'alimentation L= 2m Driver externe inclus. Patère et branchement électrique exclus, à commander séparément.

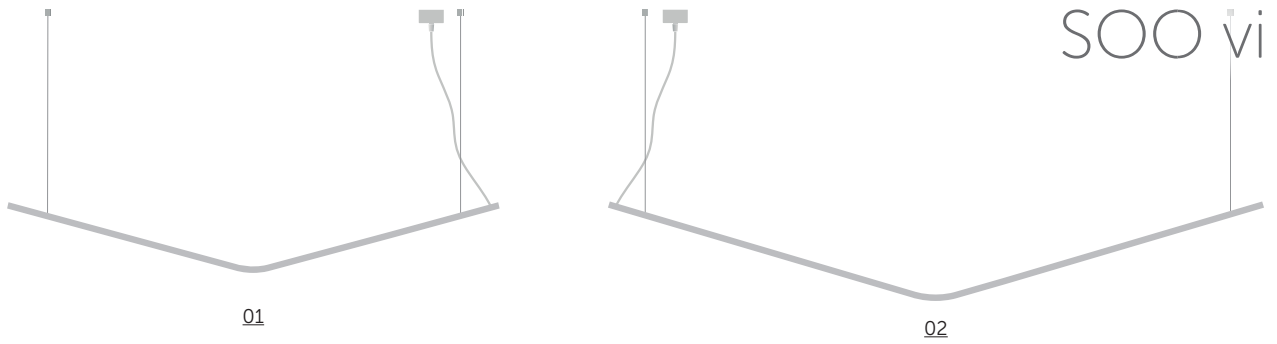

SOO vi 4000 K

Code	Diffuser	Size	Lumen Out*	Watt Tot	K	Beam angle	Driver Type	Driver Nr.	Colour
YSVI16N	OP: Opal	01	5780	68	4000	D	ON/OFF	1	○
YSVI15N		01	2890	34	4000	D	ON/OFF	1	○
YSVI21N	MP: Microprismatic	02	7650	90	4000	D	ON/OFF	1	○
YSVI20N		02	3825	45	4000	D	ON/OFF	1	○

SOO vi 3000 K

Code	Diffuser	Size	Lumen Out*	Watt Tot	K	Beam angle	Driver Type	Driver Nr.	Colour
YSVI16W	OP: Opal	01	5320	68	3000	D	ON/OFF	1	○
YSVI15W		01	2660	34	3000	D	ON/OFF	1	○
YSVI21W	MP: Microprismatic	02	7040	90	3000	D	ON/OFF	1	○
YSVI20W		02	3520	45	3000	D	ON/OFF	1	○

*Output flux with opal diffuser. With microprismatic diffuser + 10%

SOO vi STANDARD COLOUR SELECTION

● **WI** | White Irazu ● **BLL** | Black Lava

SOO vi ON REQUEST COLOUR SELECTION

● **BF** | Beige Futuna ● **SB** | Silver Bombalai ● **GK** | Gold Karkar
 ● **BL** | Bronze Lario ● **RR** | Rust Rame ● **BT** | Blue Telica

SOO vi BEAM ANGLE | DIMENSIONS



Size	X (mm)	Y (mm)	Z (mm)	Kg
01	1500	200	50	1,5
02	2000	300	50	1,9

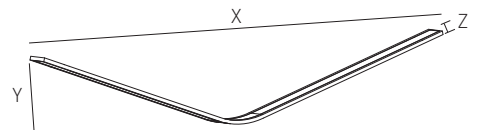

Min and Max room temperature: -20°+45° C.

SOO ACCESSORIES

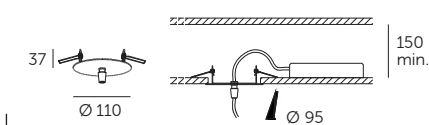

YKT10301 + ○ COLOUR

Rose ceiling for installation with ceiling panel, remote driver.

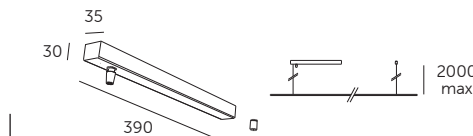

YKT10401 + ○ COLOUR

Rose ceiling for brick installation with driver housing.

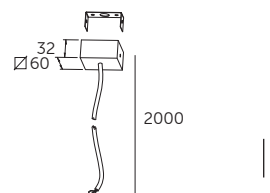

YKT10501 + ○ COLOUR

Rose ceiling for brick installation without driver housing. For remote driver 24 Volt max 5 mt.





SOOO ad



SOO ad

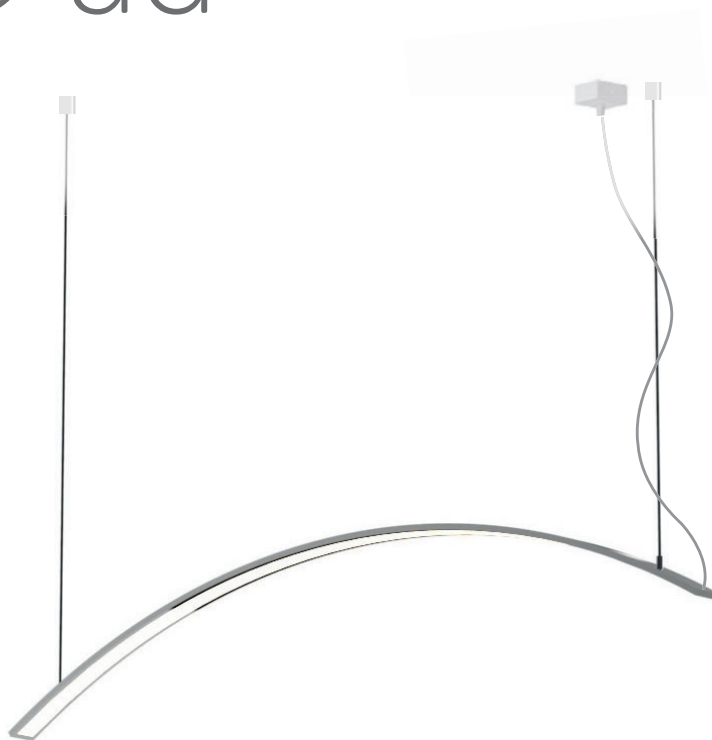

Decorative suspension lighting fitting

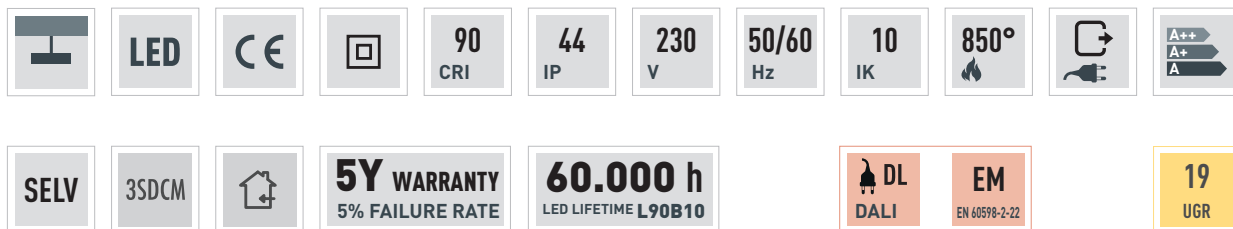

On request

Only for cod. MP

IT

Apparecchio decorativo per installazione a sospensione. Corpo ultrapiatto in estruso di alluminio calandrato. Sorgente luminosa LED diretta. Verniciatura con polveri epossidiche antigraffio. Diffusore in policarbonato opale (cod. OP), microprismato UGR 19 (cod. MP). Fornito completo di sospensioni in acciaio regolabili e cavo di alimentazione L=2m. Alimentatore incluso esterno. Rosone per collegamento elettrico non incluso, da ordinare separatamente.

ES

Luminaria decorativa de suspensión. Cuerpo ultraplano de aluminio extruido calandrado. Fuente de iluminación LED directa. Barnizado con polvo epoxi anti-rayado. Difusor de policarbonato opal (código OP), microprismato UGR19 (código MP). Cables de suspensión de acero ajustables y cable de alimentación L=2m incluidos. Balasto externo incluido. Roseta electrificada no incluida, a pedir por separada.

EN

Decorative suspension lighting fitting. Extruded linear aluminum ultra-flat body. Direct LED light source. Painted with scratch-resistant epoxy powders. Opal polycarbonate diffuser (code OP), microprismatic UGR 19 (code MP). Supplied complete with adjustable steel suspensions and power cable L = 2m. External driver included. Rose ceiling for electrical connection not included, to be ordered separately.

DE

Dekoratives Hängebeleuchtungsgerät. Ultraflacher Körper aus extrudiertem, kalandriertem Aluminium. Direkte LED-Lichtquelle. Lackiert mit kratzfesten Epoxidpulvern. Diffusor aus opalem Polycarbonat (Kode OP), mikroprismatisch UGR 19 (Kode MP). Komplett mit verstellbaren Stahlabhängungen und Netzkabel L = 2m. Externer elektronischer Treiber enthalten. Deckenbefestigung für elektrische Verbindung nicht enthalten, separat zu bestellen.

FR

Appareil décoratif en suspension. Corps extra plat en aluminium extrudé linéaire. Source lumineuse LED directe. Finition de peinture en poudre époxy anti-rayures. Diffuseur en polycarbonate opal (réf. OP), microprismé UGR 19 (réf. MP). Fourni avec filins de suspensions en acier réglables et câble d'alimentation L= 2mt. Driver externe inclus. Patère et branchement électrique exclus, à commander séparément.

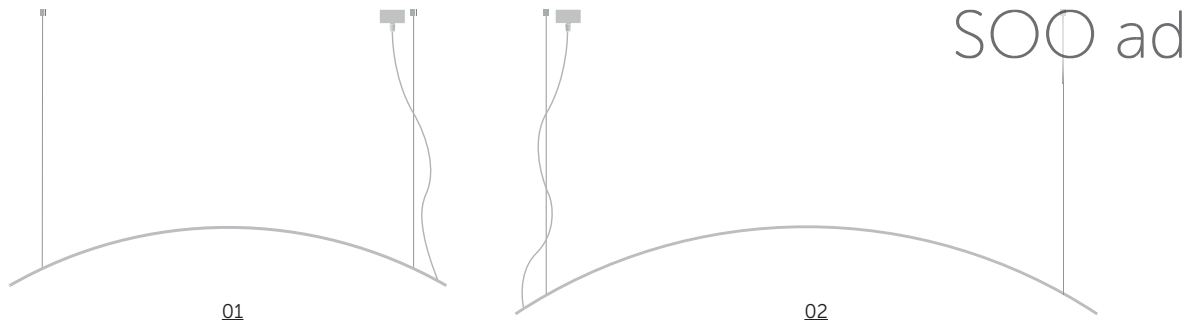

SOO ad 4000 K

Code	Diffuser	Size	Lumen Out*	Watt Tot	K	Beam angle	Driver Type	Driver Nr.	Colour
YSAD16N	OP: Opal	01	5950	70	4000	D	ON/OFF	1	○
YSAD15N		01	2975	35	4000	D	ON/OFF	1	○
YSAD21N	MP: Microprismatic	02	7990	94	4000	D	ON/OFF	1	○
YSAD20N		02	3995	47	4000	D	ON/OFF	1	○

SOO ad 3000 K

Code	Diffuser	Size	Lumen Out*	Watt Tot	K	Beam angle	Driver Type	Driver Nr.	Colour
YSAD16W	OP: Opal	01	5475	70	3000	D	ON/OFF	1	○
YSAD15W		01	2720	35	3000	D	ON/OFF	1	○
YSAD21W	MP: Microprismatic	02	7350	94	3000	D	ON/OFF	1	○
YSAD20W		02	3675	47	3000	D	ON/OFF	1	○

*Output flux with opal diffuser. With microprismatic diffuser + 10%

SOO ad STANDARD COLOUR SELECTION

● **WI** | White Irazu ● **BLL** | Black Lava

SOO ad ON REQUEST COLOUR SELECTION

● **BF** | Beige Futuna ● **SB** | Silver Bombalai ● **GK** | Gold Karkar
 ● **BL** | Bronze Lario ● **RR** | Rust Rame ● **BT** | Blue Telica

SOO ad BEAM ANGLE | DIMENSIONS

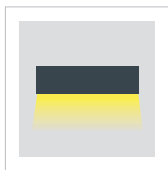

Size	X [mm]	Y [mm]	Z [mm]	Kg
01	1500	200	50	1,5
02	2000	300	50	1,9

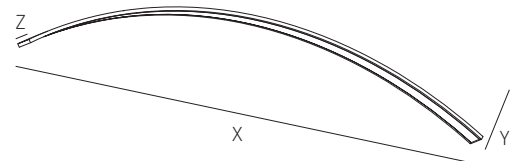

Min and Max room temperature: -20°+45° C.

SOO ACCESSORIES

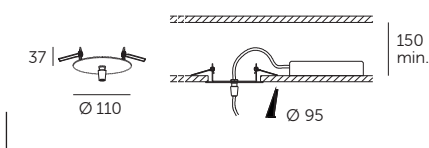

YKT10301 + ○ COLOUR

Rose ceiling for installation with ceiling panel, remote driver.

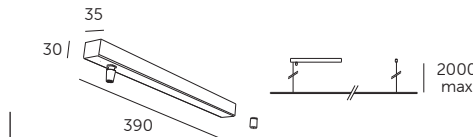

YKT10401 + ○ COLOUR

Rose ceiling for brick installation with driver housing.

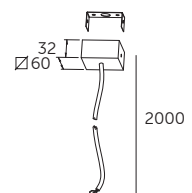

YKT10501 + ○ COLOUR

Rose ceiling for brick installation without driver housing. For remote driver 24 Volt max 5 mt.





SOOO ai



SOO ai

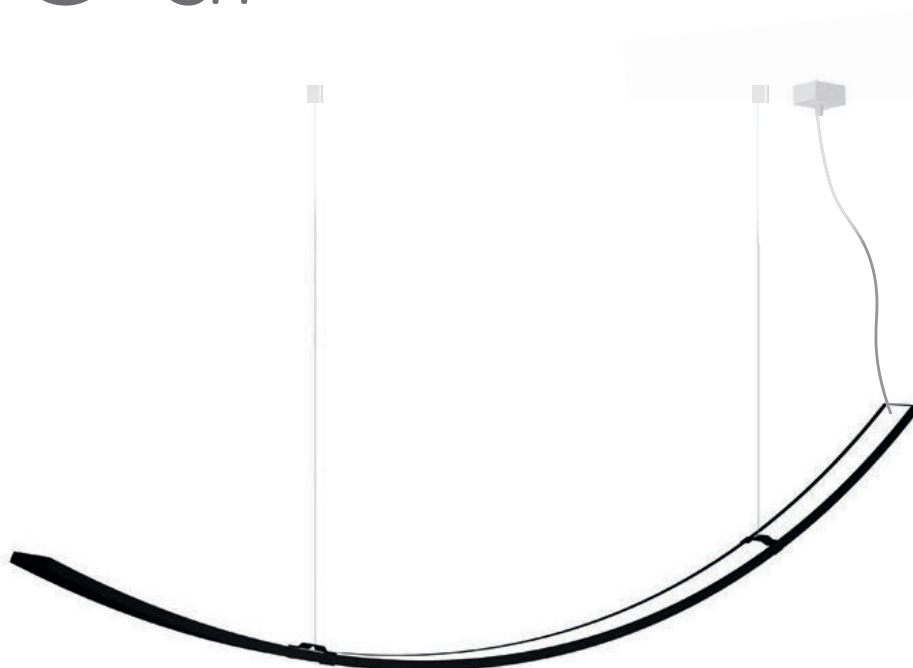

Decorative suspension lighting fitting

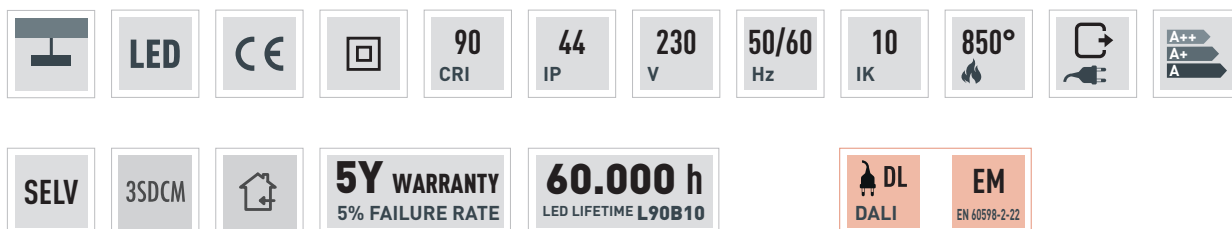

On request

IT

Apparecchio decorativo per installazione a sospensione. Corpo ultrapiatto in estruso di alluminio calandrato. Sorgente luminosa LED indiretta. Verniciatura con polveri epossidiche antigraffio. Diffusore in policarbonato opale (cod. OP), microprismato UGR 19 (cod. MP). Fornito completo di sospensioni in acciaio regolabili e cavo di alimentazione L=2m. Alimentatore incluso esterno. Rosone con collegamento elettrico non incluso, da ordinare separatamente.

ES

Luminaria decorativa de suspensión. Cuerpo ultraplano de aluminio extruido calandrado. Fuente de iluminación LED indirecta. Barnizado con polvo epoxi anti-rayado. Difusor de policarbonato opal (código OP), microprismato UGR19 (código MP). Cables de suspensión de acero ajustables y cable de alimentación L=2m incluidos. Balasto externo incluido. Roseta electrificada no incluida, a pedir por separada.

EN

Decorative suspension lighting fitting. Extruded calendered aluminum ultra-flat body. Indirect LED light source. Painted with scratch-resistant epoxy powders. Opal polycarbonate diffuser (code OP), microprismatic UGR 19 (code MP). Supplied complete with adjustable steel suspensions and power cable L = 2m. External driver included. Rose ceiling for electrical connection not included, to be ordered separately.

DE

Dekoratives Hängebeleuchtungsgerät. Ultraflacher Körper aus extrudiertem, kalandriertem Aluminium. Indirekte LED-Lichtquelle. Lackiert mit kratzfesten Epoxidpulvern. Diffusor aus opalem Polycarbonat (Kode OP), mikroprismatisch UGR 19 (Kode MP). Komplett mit verstellbaren Stahlhängungen und Netzkabel L = 2m. Externer elektronischer Treiber enthalten. Deckenbefestigung für elektrische Verbindung nicht enthalten, separat zu bestellen.

FR

Appareil décoratif en suspension. Corps extra plat en aluminium extrudé courbé. Source lumineuse LED indirecte. Finition de peinture en poudre époxy anti-rayures. Diffuseur en polycarbonate opal (réf. OP), microprismé UGR 19 (réf. MP). Fourni avec filins de suspensions en acier réglables et câble d'alimentation L= 2mt. Driver externe inclus. Patère et branchement électrique exclus, à commander séparément.

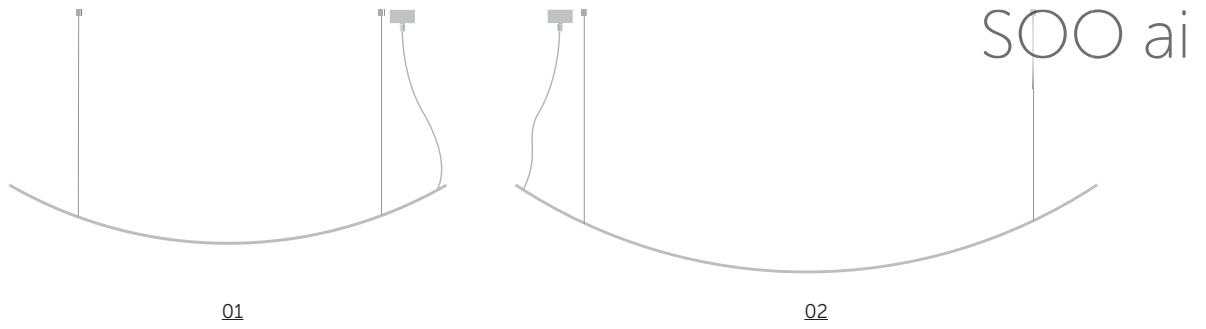

SOO ai 4000 K

Code	Diffuser	Size	Lumen Out*	Watt Tot	K	Beam angle	Driver Type	Driver Nr.	Colour
YSAI16N	OP: Opal	01	5950	70	4000	D	ON/OFF	1	○
YSAI15N		01	2975	35	4000	D	ON/OFF	1	○
YSAI21N	MP: Microprismatic	02	7990	94	4000	D	ON/OFF	1	○
YSAI20N		02	3995	47	4000	D	ON/OFF	1	○

SOO ai 3000 K

Code	Diffuser	Size	Lumen Out*	Watt Tot	K	Beam angle	Driver Type	Driver Nr.	Colour
YSAI16W	OP: Opal	01	5475	70	3000	D	ON/OFF	1	○
YSAI15W		01	2720	35	3000	D	ON/OFF	1	○
YSAI21W	MP: Microprismatic	02	7350	94	3000	D	ON/OFF	1	○
YSAI20W		02	3675	47	3000	D	ON/OFF	1	○

*Output flux with opal diffuser. With microprismatic diffuser + 10%

SOO ai STANDARD COLOUR SELECTION

● **WI** | White Irazu ● **BLL** | Black Lava

SOO ai ON REQUEST COLOUR SELECTION

● **BF** | Beige Futuna ● **SB** | Silver Bombalai ● **GK** | Gold Karkar
 ● **BL** | Bronze Lario ● **RR** | Rust Rame ● **BT** | Blue Telica

SOO ai BEAM ANGLE | DIMENSIONS

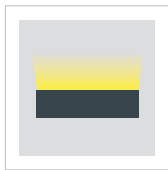

Size	X [mm]	Y [mm]	Z [mm]	Kg
01	1500	200	50	1,5
02	2000	300	50	1,9

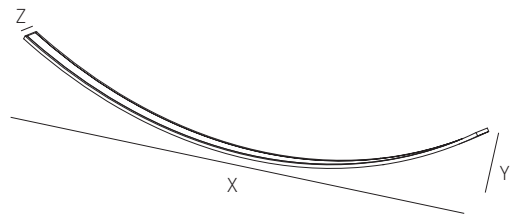

Min and Max room temperature: -20°+45° C.

SOO ACCESSORIES

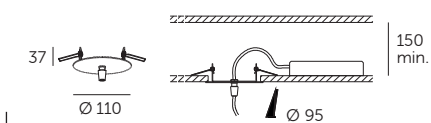

YKT10301 + ○ COLOUR

Rose ceiling for installation with ceiling panel, remote driver.

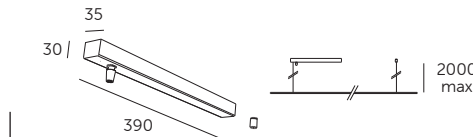

YKT10401 + ○ COLOUR

Rose ceiling for brick installation with driver housing.

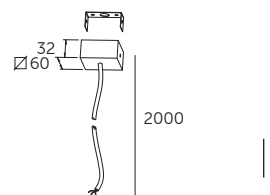

YKT10501 + ○ COLOUR

Rose ceiling for brick installation without driver housing. For remote driver 24 Volt max 5 mt.





1000S



SOO ld



Decorative suspension lighting fitting

	LED			90 CRI	44 IP	230 V	50/60 Hz	10 IK	850° 		
SELV	3SDCM		5Y WARRANTY 5% FAILURE RATE	60.000 h LED LIFETIME L90B10		EM EN 60598-2-22	19 UGR				

On request

Only for cod. MP

IT

Apparecchio decorativo per installazione a sospensione. Corpo ultrapiatto in estruso di alluminio lineare Sorgente luminosa LED diretta. Verniciatura con polveri epossidiche antigraffio. Diffusore in policarbonato opale (cod. OP), microprismato UGR 19 (cod. MP). Fornito completo di sospensioni in acciaio regolabili e cavo di alimentazione L=2m. Alimentatore incluso esterno. Rosone con collegamento elettrico non incluso, da ordinare separatamente.

ES

Luminaria decorativa de suspensión. Cuerpo ultraplano de aluminio extruido lineal. Fuente de iluminación LED directa. Barnizado con polvo epoxi anti-rayado. Difusor de policarbonato opal (código OP), microprismato UGR19 (código MP). Cables de suspensión de acero ajustables y cable de alimentación L=2m incluidos. Balasto externo incluido. Roseta electrificada no incluida, a pedir por separada.

EN

Decorative suspension lighting fitting. Extruded linear aluminum ultra-flat body. Direct LED light source. Painted with scratch-resistant epoxy powders. Opal polycarbonate diffuser (code OP), microprismatic UGR 19 (code MP). Supplied complete with adjustable steel suspensions and power cable L = 2m. External driver included. Rose ceiling for electrical connection not included, to be ordered separately.

DE

Dekoratives Hängebeleuchtungsgerät. Ultraflacher Körper aus linear extrudiertem Aluminium. Direkte LED-Lichtquelle. Lackiert mit kratzfesten Epoxidpulvern. Diffusor aus opalem Polycarbonat (Kode OP), mikroprismatisch UGR 19 (Kode MP). Komplett mit verstellbaren Stahlabhängungen und Netzkabel L = 2m. Externer elektronischer Treiber enthalten. Deckenbefestigung für elektrische Verbindung nicht enthalten, separat zu bestellen.

FR

Appareil décoratif en suspension. Corps extra plat en aluminium extrudé courbé. Source lumineuse LED indirecte. Finition de peinture en poudre époxy anti-rayures. Diffuseur en polycarbonate opal (réf. OP), microprismé UGR 19 (réf. MP). Fourni avec fils de suspensions en acier réglables et câble d'alimentation L= 2mt. Driver externe inclus. Patère et branchement électrique exclus, à commander séparément.

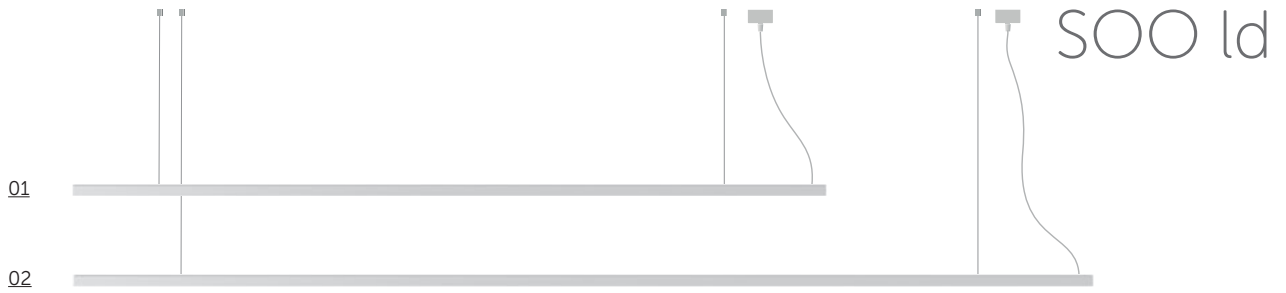

SOO ld 4000 K

Code	Diffuser	Size	Lumen Out*	Watt Tot	K	Beam angle	Driver Type	Driver Nr.	Colour
YSLD16N	OP: Opal	01	5610	66	4000	D	ON/OFF	1	○
YSLD15N		01	2805	33	4000	D	ON/OFF	1	○
YSLD21N	MP: Microprismatic	02	7480	88	4000	D	ON/OFF	1	○
YSLD20N		02	3740	44	4000	D	ON/OFF	1	○

SOO ld 3000 K

Code	Diffuser	Size	Lumen Out*	Watt Tot	K	Beam angle	Driver Type	Driver Nr.	Colour
YSLD16W	OP: Opal	01	5160	66	3000	D	ON/OFF	1	○
YSLD15W		01	2580	33	3000	D	ON/OFF	1	○
YSLD21W	MP: Microprismatic	02	6880	88	3000	D	ON/OFF	1	○
YSLD20W		02	3440	44	3000	D	ON/OFF	1	○

*Output flux with opal diffuser. With microprismatic diffuser + 10%

SOO ld STANDARD COLOUR SELECTION

- **WI** | White Irazu
- **BLL** | Black Lava

SOO ld ON REQUEST COLOUR SELECTION

- **BF** | Beige Futuna
- **SB** | Silver Bombalai
- **GK** | Gold Karkar
- **BL** | Bronze Lario
- **RR** | Rust Rame
- **BT** | Blue Telica

SOO ld BEAM ANGLE | DIMENSIONS



Size	X (mm)	Y (mm)	Z (mm)	Kg
01	1500	50	10	1,4
02	2000	50	10	1,8

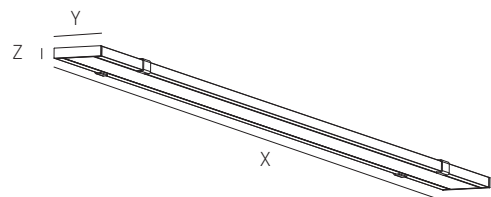

Min and Max room temperature: -20°+45° C.

SOO ACCESSORIES

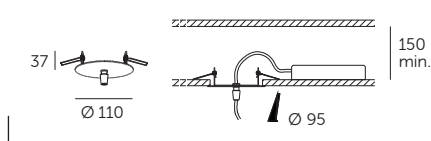

YKT10301 + ○ COLOUR

Rose ceiling for installation with ceiling panel, remote driver.

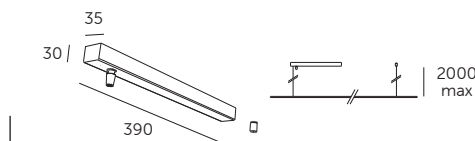

YKT10401 + ○ COLOUR

Rose ceiling for brick installation with driver housing.

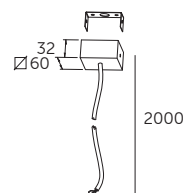

YKT10501 + ○ COLOUR

Rose ceiling for brick installation without driver housing. For remote driver 24 Volt max 5 mt.

SOO li



Decorative suspension lighting fitting

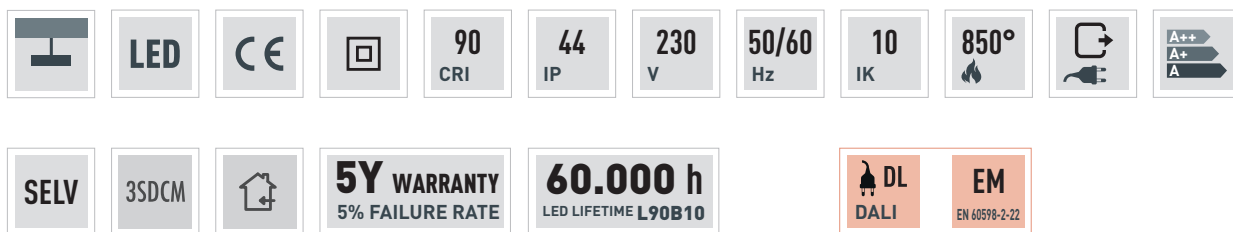

On request

IT

Apparecchio decorativo per installazione a sospensione. Corpo ultrapiatto in estruso di alluminio lineare. Sorgente luminosa LED indiretta. Verniciatura con polveri epossidiche antigraffio. Diffusore in policarbonato opale (cod. OP), microprismato UGR 19 (cod. MP). Fornito completo di sospensioni in acciaio regolabili e cavo di alimentazione L=2m. Alimentatore incluso esterno. Rosone con collegamento elettrico non incluso, da ordinare separatamente.

ES

Luminaria decorativa de suspensión. Cuerpo ultraplano de aluminio extruido lineal. Fuente de iluminación LED indirecta. Barnizado con polvo epoxi anti-rayado. Difusor de policarbonato opal (código OP), microprismato UGR19 (código MP). Cables de suspensión de acero ajustables y cable de alimentación L=2m incluidos. Balasto externo incluido. Roseta electrificada no incluida, a pedir por separada.

EN

Decorative suspension lighting fitting. Extruded linear aluminum ultra-flat body. Indirect LED light source. Painted with scratch-resistant epoxy powders. Opal polycarbonate diffuser (code OP), microprismatic UGR 19 (code MP). Supplied complete with adjustable steel suspensions and power cable L = 2m. External driver included. Rose ceiling for electrical connection not included, to be ordered separately.

DE

Dekoratives Hängebeleuchtungsgerät. Ultraflacher Körper aus linear extrudiertem Aluminium. Indirekte LED-Lichtquelle. Lackiert mit kratzfesten Epoxidpulvern. Diffusor aus opalem Polycarbonat (Kode OP), mikroprismatisch UGR 19 (Kode MP). Komplett mit verstellbaren Stahlhängungen und Netzkabel L = 2m. Externer elektronischer Treiber enthalten. Deckenbefestigung für elektrische Verbindung nicht enthalten, separat zu bestellen.

FR

Appareil décoratif en suspension. Corps extra plat en aluminium extrudé courbé. Source lumineuse LED indirecte. Finition de peinture en poudre époxy anti-rayures. Diffuseur en polycarbonate opal (réf. OP), microprismé UGR 19 (réf. MP). Fourni avec fils de suspensions en acier réglables et câble d'alimentation L= 2mt. Driver externe inclus. Patère et branchement électrique exclus, à commander séparément.

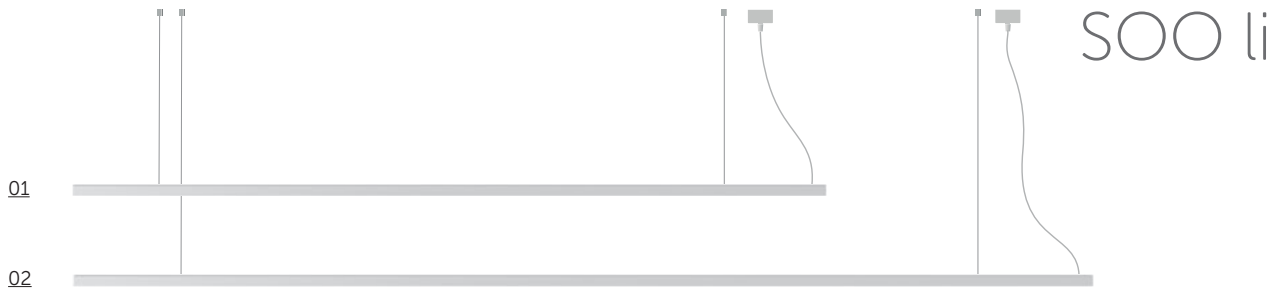

SOO li 4000 K

Code	Diffuser	Size	Lumen Out*	Watt Tot	K	Beam angle	Driver Type	Driver Nr.	Colour
YSLI16N	OP: Opal	01	5610	66	4000	D	ON/OFF	1	○
YSLI15N		01	2805	33	4000	D	ON/OFF	1	○
YSLI21N	MP: Microprismatic	02	7480	88	4000	D	ON/OFF	1	○
YSLI20N		02	3740	44	4000	D	ON/OFF	1	○

SOO li 3000 K

Code	Diffuser	Size	Lumen Out*	Watt Tot	K	Beam angle	Driver Type	Driver Nr.	Colour
YSLI16W	OP: Opal	01	5160	66	3000	D	ON/OFF	1	○
YSLI15W		01	2580	33	3000	D	ON/OFF	1	○
YSLI21W	MP: Microprismatic	02	6880	88	3000	D	ON/OFF	1	○
YSLI20W		02	3440	44	3000	D	ON/OFF	1	○

*Output flux with opal diffuser. With microprismatic diffuser + 10%

SOO li STANDARD COLOUR SELECTION

- **WI** | White Irazu
- **BLL** | Black Lava

SOO li ON REQUEST COLOUR SELECTION

- **BF** | Beige Futuna
- **SB** | Silver Bombalai
- **GK** | Gold Karkar
- **BL** | Bronze Lario
- **RR** | Rust Rame
- **BT** | Blue Telica

SOO li BEAM ANGLE | DIMENSIONS



Size	X [mm]	Y [mm]	Z [mm]	Kg
01	1500	50	10	1,4
02	2000	50	10	1,8

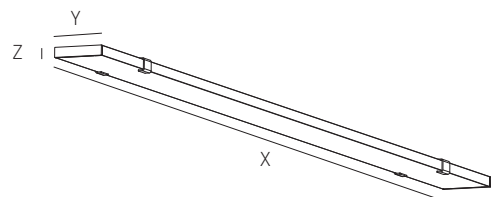

Min and Max room temperature: -20°+45° C.

SOO ACCESSORIES

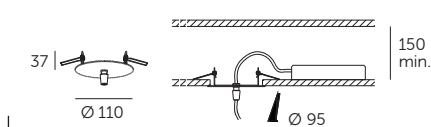

YKT10301 + ○ COLOUR

Rose ceiling for installation with ceiling panel, remote driver.

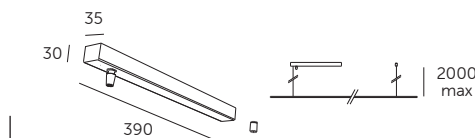

YKT10401 + ○ COLOUR

Rose ceiling for brick installation with driver housing.

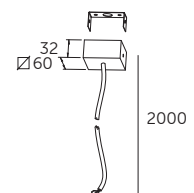

YKT10501 + ○ COLOUR

Rose ceiling for brick installation without driver housing. For remote driver 24 Volt max 5 mt.





S
O
O
S



SOO sd



Decorative suspension lighting fitting

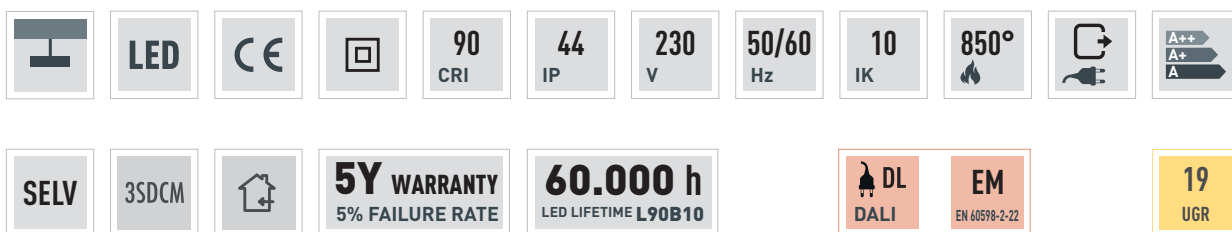

On request

Only for cod. MP

IT

Apparecchio decorativo per installazione a sospensione. Corpo ultrapiatto in estruso di alluminio calandrato. Sorgente luminosa LED diretta. Verniciatura con polveri epossidiche antigraffio. Diffusore in policarbonato opale (cod. OP), microprismatico UGR 19 (cod. MP). Fornito completo di sospensioni in acciaio regolabili e cavo di alimentazione L=2m. Alimentatore incluso esterno. Rosone con collegamento elettrico non incluso, da ordinare separatamente.

ES

Luminaria decorativa de suspensión. Cuerpo ultraplano de aluminio extruido calandrado. Fuente de iluminación LED directa. Barnizado con polvo epoxi anti-rayado. Difusor de policarbonato opal (código OP), microprismatico UGR19 (código MP). Cables de suspensión de acero ajustables y cable de alimentación L=2m incluidos. Balasto externo incluido. Roseta electrificada no incluida, a pedir por separada.

EN

Decorative suspension lighting fitting. Extruded calendered aluminum ultra-flat body. Direct LED light source. Painted with scratch-resistant epoxy powders. Opal polycarbonate diffuser (code OP), microprismatic UGR 19 (code MP). Supplied complete with adjustable steel suspensions and power cable L = 2m. External driver included. Rose ceiling for electrical connection not included, to be ordered separately.

DE

Dekoratives Hängebeleuchtungsgerät. Ultraflacher Körper aus extrudiertem, kalandriertem Aluminium. Direkte LED-Lichtquelle. Lackiert mit kratzfesten Epoxidpulvern. Diffusor aus opalem Polycarbonat (Kode OP), mikroprismatisch UGR 19 (Kode MP). Komplett mit verstellbaren Stahlabhängungen und Netzkabel L = 2m. Externer elektronischer Treiber enthalten. Deckenbefestigung für elektrische Verbindung nicht enthalten, separat zu bestellen.

FR

Appareil décoratif en suspension. Corps extra plat en aluminium extrudé courbé. Source lumineuse LED directe. Finition de peinture en poudre époxy anti-rayures. Diffuseur en polycarbonate opal (réf. OP), microprismé UGR 19 (réf. MP). Fourni avec fils de suspensions en acier réglables et câble d'alimentation L= 2mt. Driver externe inclus. Patère et branchement électrique exclus, à commander séparément.



01



02

SOO sd

SOO sd 4000 K

Code	Diffuser	Size	Lumen Out*	Watt Tot	K	Beam angle	Driver Type	Driver Nr.	Colour
YSSD16N	OP: Opal	01	5780	68	4000	D	ON/OFF	1	○
YSSD15N		01	2890	34	4000	D	ON/OFF	1	○
YSSD21N	MP: Microprismatic	02	7650	90	4000	D	ON/OFF	1	○
YSSD20N		02	3825	45	4000	D	ON/OFF	1	○

SOO sd 3000 K

Code	Diffuser	Size	Lumen Out*	Watt Tot	K	Beam angle	Driver Type	Driver Nr.	Colour
YSSD16W	OP: Opal	01	5320	68	3000	D	ON/OFF	1	○
YSSD15W		01	2660	34	3000	D	ON/OFF	1	○
YSSD21W	MP: Microprismatic	02	7940	90	3000	D	ON/OFF	1	○
YSSD20W		02	3520	45	3000	D	ON/OFF	1	○

*Output flux with opal diffuser. With microprismatic diffuser + 10%

SOO sd STANDARD COLOUR SELECTION

- **WI** | White Irazu
- **BLL** | Black Lava

SOO sd ON REQUEST COLOUR SELECTION

- **BF** | Beige Futuna
- **SB** | Silver Bombalai
- **GK** | Gold Karkar
- **BL** | Bronze Lario
- **RR** | Rust Rame
- **BT** | Blue Telica

SOO sd BEAM ANGLE | DIMENSIONS



Size	X [mm]	Y [mm]	Z [mm]	Kg
01	1500	180	50	1,5
02	2000	220	50	1,9

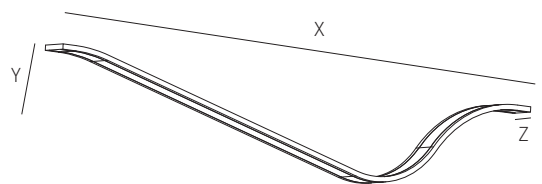

Min and Max room temperature: -20°+45° C.

SOO ACCESSORIES

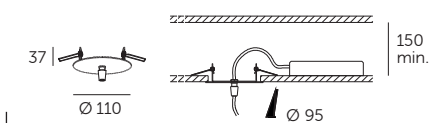

YKT10301 + ○ COLOUR

Rose ceiling for installation with ceiling panel, remote driver.

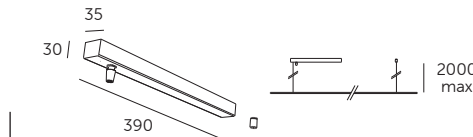

YKT10401 + ○ COLOUR

Rose ceiling for brick installation with driver housing.

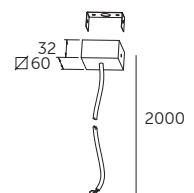

YKT10501 + ○ COLOUR

Rose ceiling for brick installation without driver housing. For remote driver 24 Volt max 5 mt.

SOO si



Decorative suspension lighting fitting

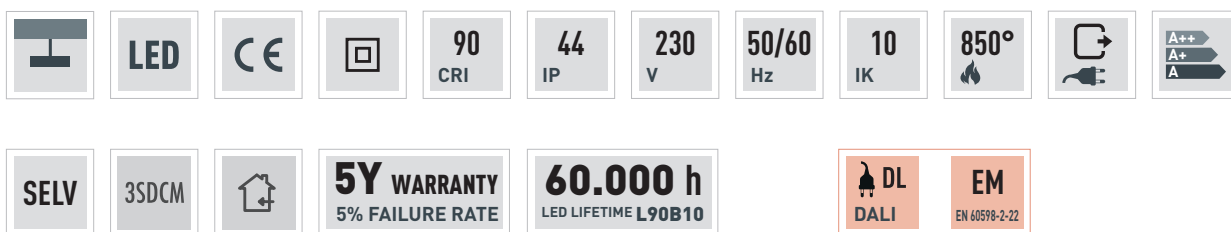

On request

IT

Apparecchio decorativo per installazione a sospensione. Corpo ultrapiatto in estruso di alluminio calandrato. Sorgente luminosa LED indiretta. Verniciatura con polveri epossidiche antigraffio. Diffusore in policarbonato opale (cod. OP), microprismato UGR 19 (cod. MP). Fornito completo di sospensioni in acciaio regolabili e cavo di alimentazione L=2m. Alimentatore incluso esterno. Rosone con collegamento elettrico non incluso, da ordinare separatamente.

ES

Luminaria decorativa de suspensión. Cuerpo ultraplano de aluminio extruido calandrado. Fuente de iluminación LED indirecta. Barnizado con polvo epoxi anti-rayado. Difusor de policarbonato opal (código OP), microprismato UGR19 (código MP). Cables de suspensión de acero ajustables y cable de alimentación L=2m incluidos. Balasto externo incluido. Roseta electrificada no incluida, a pedir por separada.

EN

Decorative suspension lighting fitting. Extruded calendered aluminum ultra-flat body. Indirect LED light source. Painted with scratch-resistant epoxy powders. Opal polycarbonate diffuser (code OP), microprismatic UGR 19 (code MP). Supplied complete with adjustable steel suspensions and power cable L = 2m. External driver included. Rose ceiling for electrical connection not included, to be ordered separately.

DE

Dekoratives Hängebeleuchtungsgerät. Ultraflacher Körper aus extrudiertem, kalandriertem Aluminium. Indirekte LED-Lichtquelle. Lackiert mit kratzfesten Epoxidpulvern. Diffusor aus opalem Polycarbonat (Kode OP), mikroprismatisch UGR 19 (Kode MP). Komplett mit verstellbaren Stahlabhängungen und Netzkabel L = 2m. Externer elektronischer Treiber enthalten. Deckenbefestigung für elektrische Verbindung nicht enthalten, separat zu bestellen.

FR

Appareil décoratif en suspension. Corps extra plat en aluminium extrudé courbé. Source lumineuse LED indirecte. Finition de peinture en poudre époxy anti-rayures. Diffuseur en polycarbonate opal (réf. OP), microprismé UGR 19 (réf. MP). Fourni avec fils de suspensions en acier réglables et câble d'alimentation L= 2mt. Driver externe inclus. Patère et branchement électrique exclus, à commander séparément.



01



02

SOO si

SOO si 4000 K

Code	Diffuser	Size	Lumen Out*	Watt Tot	K	Beam angle	Driver Type	Driver Nr.	Colour
YSSI16N	OP: Opal	01	5780	68	4000	D	ON/OFF	1	○
YSSI15N		01	2890	34	4000	D	ON/OFF	1	○
YSSI21N	MP: Microprismatic	02	7650	90	4000	D	ON/OFF	1	○
YSSI20N		02	3825	45	4000	D	ON/OFF	1	○

SOO si 3000 K

Code	Diffuser	Size	Lumen Out*	Watt Tot	K	Beam angle	Driver Type	Driver Nr.	Colour
YSSI16W	OP: Opal	01	5320	68	3000	D	ON/OFF	1	○
YSSI15W		01	2660	34	3000	D	ON/OFF	1	○
YSSI21W	MP: Microprismatic	02	7040	90	3000	D	ON/OFF	1	○
YSSI20W		02	3520	45	3000	D	ON/OFF	1	○

*Output flux with opal diffuser. With microprismatic diffuser + 10%

SOO si STANDARD COLOUR SELECTION

● **WI** | White Irazu ● **BLL** | Black Lava

SOO si ON REQUEST COLOUR SELECTION

● **BF** | Beige Futuna ● **SB** | Silver Bombalai ● **GK** | Gold Karkar
 ● **BL** | Bronze Lario ● **RR** | Rust Rame ● **BT** | Blue Telica

SOO si BEAM ANGLE | DIMENSIONS



Size	X [mm]	Y [mm]	Z [mm]	Kg
01	1500	180	50	1,5
02	2000	220	50	1,9

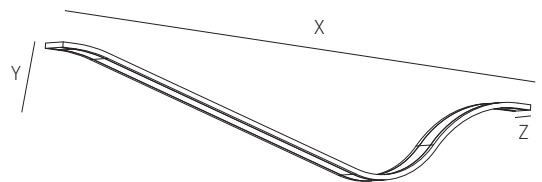

Min and Max room temperature: -20°+45° C.

SOO ACCESSORIES

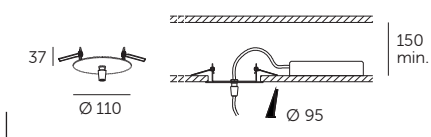

YKT10301 + ○ COLOUR

Rose ceiling for installation with ceiling panel, remote driver.

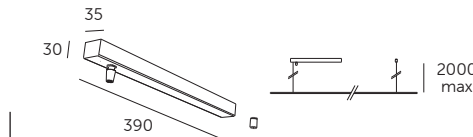

YKT10401 + ○ COLOUR

Rose ceiling for brick installation with driver housing.

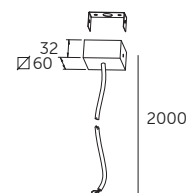

YKT10501 + ○ COLOUR

Rose ceiling for brick installation without driver housing. For remote driver 24 Volt max 5 mt.





S O O E



SOO ee



Decorative suspension lighting fitting

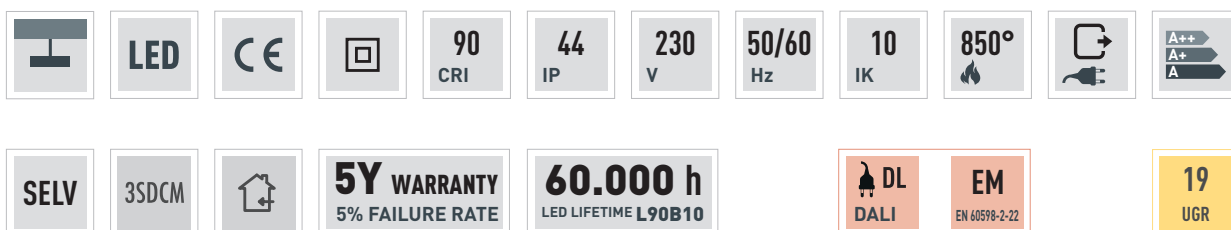

On request

Only for cod. MP

IT

Apparecchio decorativo per installazione a sospensione. Corpo ultrapiatto in estruso di alluminio calandrato. Sorgente luminosa LED esterna. Verniciatura con polveri epossidiche antigraffio. Diffusore in policarbonato opale (cod. OP), microprismato UGR 19 (cod. MP). Fornito completo di sospensioni in acciaio regolabili e cavo di alimentazione L=2m. Alimentatore incluso esterno. Rosone con collegamento elettrico non incluso, da ordinare separatamente.

ES

Luminaria decorativa de suspensión. Cuerpo ultraplano de aluminio extruido calandrado. Fuente de iluminación LED externo. Barnizado con polvo epoxi anti-rayado. Difusor de policarbonato opal (código OP), microprismato UGR19 (código MP). Cables de suspensión de acero ajustables y cable de alimentación L=2m incluidos. Balasto externo incluido. Roseta electrificada no incluida, a pedir por separada.

EN

Decorative suspension lighting fitting. Extruded calendered aluminum ultra-flat body. External LED light source. Painted with scratch-resistant epoxy powders. Opal polycarbonate diffuser (code OP), microprismatic UGR 19 (code MP). Supplied complete with adjustable steel suspensions and power cable L = 2m. External driver included. Rose ceiling for electrical connection not included, to be ordered separately.

DE

Dekoratives Hängebeleuchtungsgerät. Ultraflacher Körper aus extrudiertem, kalandriertem Aluminium. Externe LED-Lichtquelle. Lackiert mit kratzfesten Epoxidpulvern. Diffusor aus opalem Polycarbonat (Kode OP), mikroprismatisch UGR 19 (Kode MP) Komplett mit verstellbaren Stahlhängungen und Netzkabel L = 2m. Externer elektronischer Treiber enthalten. Deckenbefestigung für elektrische Verbindung nicht enthalten, separat zu bestellen.

FR

Appareil décoratif en suspension. Corps extra plat en aluminium extrudé courbé. Source lumineuse LED externe. Finition de peinture en poudre époxy anti-rayures. Diffuseur en polycarbonate opal (réf. OP), microprismé UGR 19 (réf. MP). Fourni avec fils de suspensions en acier réglables et câble d'alimentation L= 2mt. Driver externe inclus. Patère et branchement électrique exclus, à commander séparément.



01



02

SOO ee 4000 K

Code	Diffuser	Size	Lumen Out*	Watt Tot	K	Beam angle	Driver Type	Driver Nr.	Colour
YSEE16N	OP: Opal	01	12070	142	4000	D	ON/OFF	1	○
YSEE15N		01	6035	71	4000	D	ON/OFF	1	○
YSEE21N	MP: Microprismatic	02	15640	192	4000	D	ON/OFF	1	○
YSEE20N		02	7820	96	4000	D	ON/OFF	1	○

SOO ee 3000 K

Code	Diffuser	Size	Lumen Out*	Watt Tot	K	Beam angle	Driver Type	Driver Nr.	Colour
YSEE16W	OP: Opal	01	11120	142	3000	D	ON/OFF	1	○
YSEE15W		01	5560	71	3000	D	ON/OFF	1	○
YSEE21W	MP: Microprismatic	02	14400	192	3000	D	ON/OFF	1	○
YSEE20W		02	7200	96	3000	D	ON/OFF	1	○

*Output flux with opal diffuser. With microprismatic diffuser + 10%

SOO ee STANDARD COLOUR SELECTION

● **WI** | White Irazu ● **BLL** | Black Lava

SOO ee ON REQUEST COLOUR SELECTION

● **BF** | Beige Futuna ● **SB** | Silver Bombalai ● **GK** | Gold Karkar
 ● **BL** | Bronze Lario ● **RR** | Rust Rame ● **BT** | Blue Telica

SOO ee BEAM ANGLE | DIMENSIONS

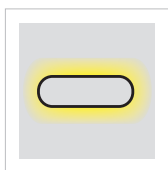

Size	X [mm]	Y [mm]	Z [mm]	Kg
01	1500	300	50	3,0
02	2000	400	50	4,0

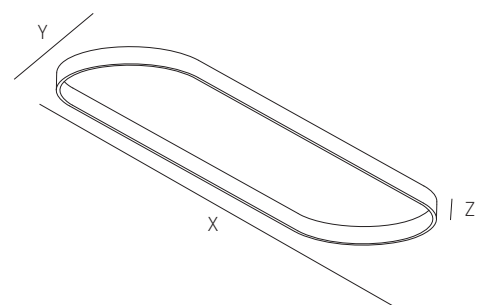

Min and Max room temperature: -20°+45° C.

SOO ACCESSORIES

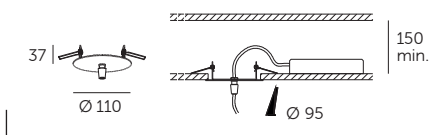

YKT10301 + ○ COLOUR

Rose ceiling for installation with ceiling panel, remote driver.

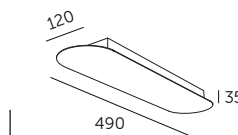

YSEEKTRO + ○ COLOUR

Rose ceiling for brick installation with driver housing.

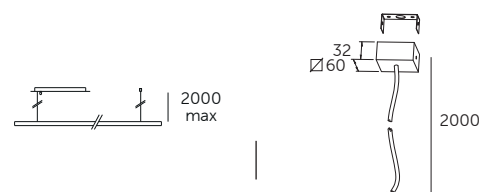

YKT10501 + ○ COLOUR

Rose ceiling for brick installation without driver housing. For remote driver 24 Volt max 5 mt.

SOO ei



Decorative suspension lighting fitting

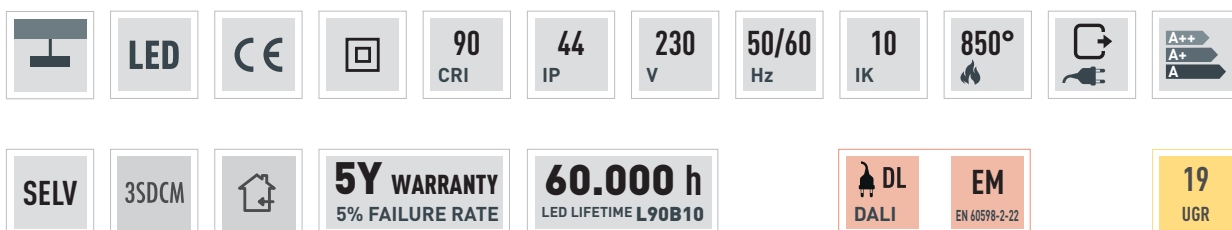

On request

Only for cod. MP

IT

Apparecchio decorativo per installazione a sospensione. Corpo ultrapiatto in estruso di alluminio calandrato. Sorgente luminosa LED interna. Verniciatura con polveri epossidiche antigraffio. Diffusore in policarbonato opale (cod. OP), microprismato UGR 19 (cod. MP). Fornito completo di sospensioni in acciaio regolabili e cavo di alimentazione L=2m. Alimentatore incluso esterno. Rosone con collegamento elettrico non incluso, da ordinare separatamente.

ES

Luminaria decorativa de suspensión. Cuerpo ultraplano de aluminio extruido calandrado. Fuente de iluminación LED interno. Barnizado con polvo epoxi anti-rayado. Difusor de policarbonato opal (código OP), microprismato UGR19 (código MP). Cables de suspensión de acero ajustables y cable de alimentación L=2m incluidos. Balasto externo incluido. Roseta electrificada no incluida, a pedir por separada.

EN

Decorative suspension lighting fitting. Extruded calendered aluminum ultra-flat body. Internal LED light source. Painted with scratch-resistant epoxy powders. Opal polycarbonate diffuser (code OP), microprismatic UGR 19 (code MP). Supplied complete with adjustable steel suspensions and power cable L = 2m. External driver included. Rose ceiling for electrical connection not included, to be ordered separately.

DE

Dekoratives Hängebeleuchtungsgerät. Ultraflacher Körper aus extrudiertem, kalandriertem Aluminium. Interne LED-Lichtquelle. Lackiert mit kratzfesten Epoxidpulvern. Diffusor aus opalem Polycarbonat (Kode OP), mikroprismatisch UGR 19 (Kode MP). Komplett mit verstellbaren Stahlabhängungen und Netzkabel L = 2m. Externer elektronischer Treiber enthalten. Deckenbefestigung für elektrische Verbindung nicht enthalten, separat zu bestellen.

FR

Appareil décoratif en suspension. Corps extra plat en aluminium extrudé courbé. Source lumineuse LED interne. Finition de peinture en poudre époxy anti-rayures. Diffuseur en polycarbonate opal (réf. OP), microprismé UGR 19 (réf. MP). Fourni avec fils de suspensions en acier réglables et câble d'alimentation L= 2mt. Driver externe inclus. Patère et branchement électrique exclus, à commander séparément.



01



02

SOO ei 4000 K

Code	Diffuser	Size	Lumen Out*	Watt Tot	K	Beam angle	Driver Type	Driver Nr.	Colour
YSEI16N	OP: Opal	01	12070	142	4000	D	ON/OFF	1	○
YSEI15N		01	6035	71	4000	D	ON/OFF	1	○
YSEI21N	MP: Microprismatic	02	15640	192	4000	D	ON/OFF	1	○
YSEI20N		02	7820	96	4000	D	ON/OFF	1	○

SOO ei 3000 K

Code	Diffuser	Size	Lumen Out*	Watt Tot	K	Beam angle	Driver Type	Driver Nr.	Colour
YSEI16W	OP: Opal	01	11120	142	3000	D	ON/OFF	1	○
YSEI15W		01	5560	71	3000	D	ON/OFF	1	○
YSEI21W	MP: Microprismatic	02	14400	192	3000	D	ON/OFF	1	○
YSEI20W		02	7200	96	3000	D	ON/OFF	1	○

*Output flux with opal diffuser. With microprismatic diffuser + 10%

SOO ei STANDARD COLOUR SELECTION

● **WI** | White Irazu ● **BLL** | Black Lava

SOO ei ON REQUEST COLOUR SELECTION

● **BF** | Beige Futuna ● **SB** | Silver Bombalai ● **GK** | Gold Karkar
 ● **BL** | Bronze Lario ● **RR** | Rust Rame ● **BT** | Blue Telica

SOO ei BEAM ANGLE | DIMENSIONS

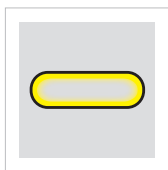

Size	X [mm]	Y [mm]	Z [mm]	Kg
01	1500	300	50	3,0
02	2000	400	50	4,0

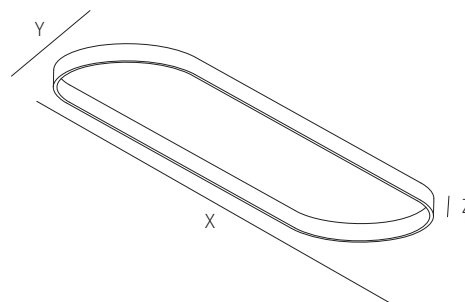

Min and Max room temperature: -20°+45° C.

SOO ACCESSORIES

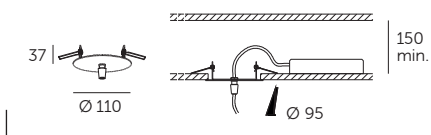

YKT10301 + ○ COLOUR

Rose ceiling for installation with ceiling panel, remote driver.

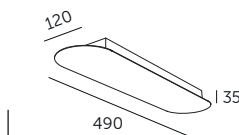

YSEEKTRO + ○ COLOUR

Rose ceiling for brick installation with driver housing.

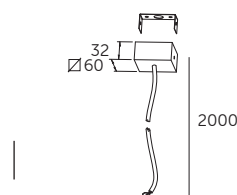
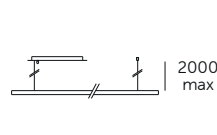

YKT10501 + ○ COLOUR

Rose ceiling for brick installation without driver housing. For remote driver 24 Volt max 5 mt.





SOOR



SOO re



Decorative suspension lighting fitting

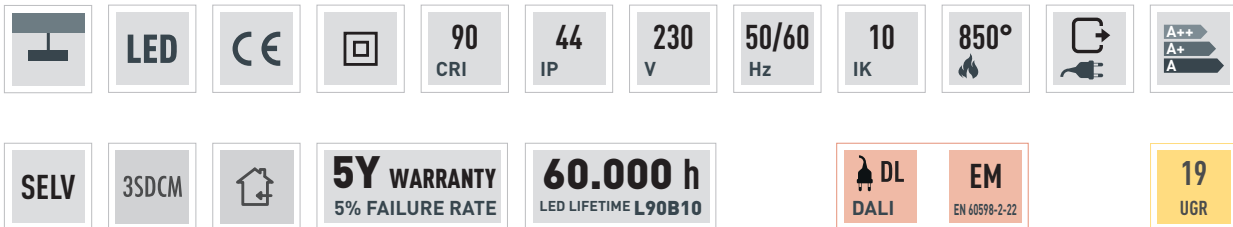

On request

Only for cod. MP

IT

Apparecchio decorativo per installazione a sospensione. Corpo ultrapiatto in estruso di alluminio calandrato. Sorgente luminosa LED esterna. Verniciatura con polveri epossidiche antigraffio. Diffusore in policarbonato opale (cod. OP), microprismato UGR 19 (cod. MP). Fornito completo di sospensioni in acciaio regolabili e cavo di alimentazione L=2m. Alimentatore incluso esterno. Rosone con collegamento elettrico non incluso, da ordinare separatamente.

ES

Luminaria decorativa de suspensión. Cuerpo ultraplano de aluminio extruido calandrado. Fuente de iluminación LED externo. Barnizado con polvo epoxi anti-rayado. Difusor de policarbonato opal (código OP), microprismato UGR19 (código MP). Cables de suspensión de acero ajustables y cable de alimentación L=2m incluidos. Balasto externo incluido. Roseta electrificada no incluida, a pedir por separada.

EN

Decorative suspension lighting fitting. Extruded calendered aluminum ultra-flat body. External LED light source. Painted with scratch-resistant epoxy powders. Opal polycarbonate diffuser (code OP), microprismatic UGR 19 (code MP). Supplied complete with adjustable steel suspensions and power cable L = 2m. External driver included. Rose ceiling for electrical connection not included, to be ordered separately.

DE

Dekoratives Hängebeleuchtungsgerät. Ultraflacher Körper aus extrudiertem, kalandriertem Aluminium. Externe LED-Lichtquelle. Lackiert mit kratzfesten Epoxidpulvern. Diffusor aus opalem Polycarbonat (Kode OP), mikroprismatisch UGR 19 (Kode MP). Komplett mit verstellbaren Stahlabhängungen und Netzkabel L = 2m. Externer elektronischer Treiber enthalten. Deckenbefestigung für elektrische Verbindung nicht enthalten, separat zu bestellen.

FR

Appareil décoratif en suspension. Corps extra plat en aluminium extrudé courbé. Source lumineuse LED externe. Finition de peinture en poudre époxy anti-rayures. Diffuseur en polycarbonate opal (réf. OP), microprismé UGR 19 (réf. MP). Fourni avec fils de suspensions en acier réglables et câble d'alimentation L= 2mt. Driver externe inclus. Patère et branchement électrique exclus, à commander séparément.

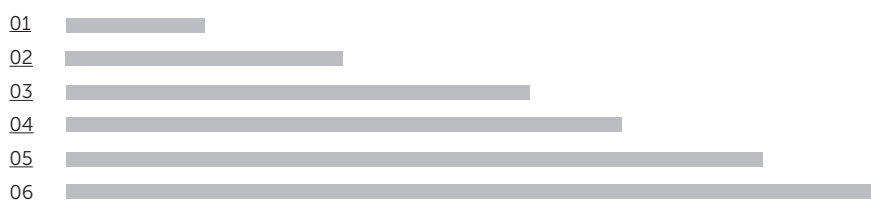

SOO re 4000 K

Code	Diffuser	Size	Lumen Out*	Watt Tot	K	Beam angle	Driver Type	Driver Nr.	Colour
YSRE03N		01	1615	19	4000	D	ON/OFF	1	○
YSRE06N	OP: Opal	02	3400	40	4000	D	ON/OFF	1	○
YSRE10N		03	5700	67	4000	D	ON/OFF	1	○
YSRE12N	MP: Microprismatic	04	6848	82	4000	D	ON/OFF	1	○
YSRE15N		05	8500	100	4000	D	ON/OFF	1	○
YSRE17N		06	9350	110	4000	D	ON/OFF	1	○

SOO re 3000 K

Code	Diffuser	Size	Lumen Out*	Watt Tot	K	Beam angle	Driver Type	Driver Nr.	Colour
YSRE03W		01	1485	19	3000	D	ON/OFF	1	○
YSRE06W	OP: Opal	02	3130	40	3000	D	ON/OFF	1	○
YSRE10W		03	5250	67	3000	D	ON/OFF	1	○
YSRE12W	MP: Microprismatic	04	6300	82	3000	D	ON/OFF	1	○
YSRE15W		05	7820	100	3000	D	ON/OFF	1	○
YSRE17W		06	8600	110	3000	D	ON/OFF	1	○

*Output flux with opal diffuser. With microprismatic diffuser + 10%

SOO re STANDARD COLOUR SELECTION

● **WI** | White Irazu ● **BLL** | Black Lava

SOO re ON REQUEST COLOUR SELECTION

● **BF** | Beige Futuna ● **SB** | Silver Bombalai ● **GK** | Gold Karkar
 ● **BL** | Bronze Lario ● **RR** | Rust Rame ● **BT** | Blue Telica

SOO re BEAM ANGLE | DIMENSIONS

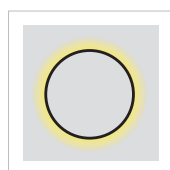

Size	X* [mm]	Y [mm]	Z [mm]	Kg
01	∅ 300	50	10	0,8
02	∅ 600	50	10	1,7
03	∅ 1000	50	10	2,8
04	∅ 1200	50	10	3,4
05	∅ 1500	50	10	4,5
06	∅ 1700	50	10	5,0

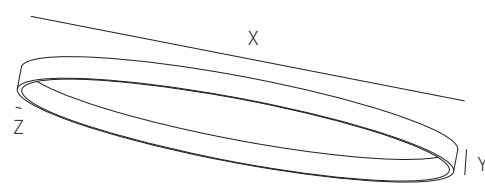

*Customizable diameters between ∅ 300mm and ∅ 1700mm

Min and Max room temperature: -20°+45° C.

SOO ACCESSORIES

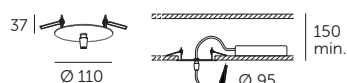

KT10301 + ○ COLOUR

Rose ceiling for installation with ceiling panel, remote driver.

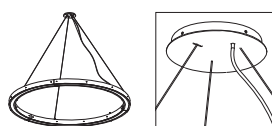

YSR-KRO230 + ○ COLOUR (max 60W)

∅ 230 H45

YSR-KRO290 + ○ COLOUR (max 110W)

∅ 290 H45

Rose ceiling for brick installation with driver housing.

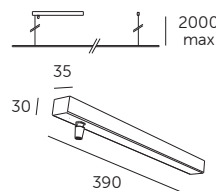

YKT10401 + ○ COLOUR

Rose ceiling for brick installation with driver housing.



YKT10402 + ○ COLOUR

Rose ceiling for brick installation with driver housing.

SOO ri



Decorative suspension lighting fitting

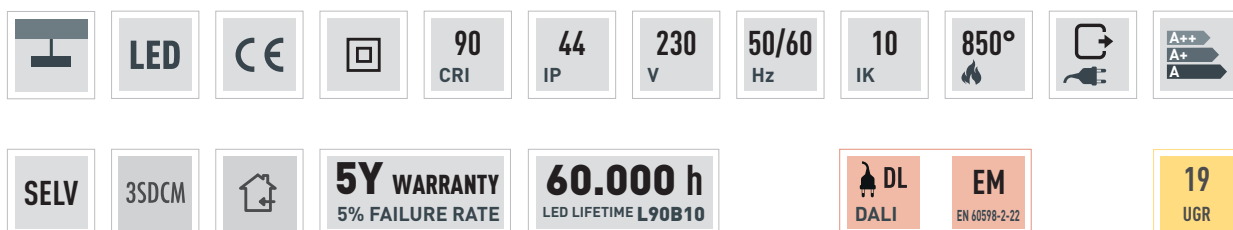

On request

Only for cod. MP

IT

Apparecchio decorativo per installazione a sospensione. Corpo ultrapiatto in estruso di alluminio calandrato. Sorgente luminosa LED interna. Verniciatura con polveri epossidiche antigraffio. Diffusore in policarbonato opale (cod. OP), microprismato UGR 19 (cod. MP). Fornito completo di sospensioni in acciaio regolabili e cavo di alimentazione L=2m. Alimentatore incluso esterno. Rosone con collegamento elettrico non incluso, da ordinare separatamente.

ES

Luminaria decorativa de suspensión. Cuerpo ultraplano de aluminio extruido calandrado. Fuente de iluminación LED interno. Barnizado con polvo epoxi anti-rayado. Difusor de policarbonato opal (código OP), microprismato UGR19 (código MP). Cables de suspensión de acero ajustables y cable de alimentación L=2m incluidos. Balasto externo incluido. Roseta electrificada no incluida, a pedir por separada.

EN

Decorative suspension lighting fitting. Extruded calendered aluminum ultra-flat body. Internal LED light source. Painted with scratch-resistant epoxy powders. Opal polycarbonate diffuser (code OP), microprismatic UGR 19 (code MP). Supplied complete with adjustable steel suspensions and power cable L = 2m. External driver included. Rose ceiling for electrical connection not included, to be ordered separately.

DE

Dekoratives Hängebeleuchtungsgerät. Ultraflacher Körper aus extrudiertem, kalandriertem Aluminium. Interne LED-Lichtquelle. Lackiert mit kratzfesten Epoxidpulvern. Diffusor aus opalem Polycarbonat (Kode OP), mikroprismatisch UGR 19 (Kode MP). Komplett mit verstellbaren Stahlabhängungen und Netzkabel L = 2m. Externer elektronischer Treiber enthalten. Deckenbefestigung für elektrische Verbindung nicht enthalten, separat zu bestellen.

FR

Appareil décoratif en suspension. Corps extra plat en aluminium extrudé courbé. Source lumineuse LED interne. Finition de peinture en poudre époxy anti-rayures. Diffuseur en polycarbonate opal (réf. OP), microprismé UGR 19 (réf. MP). Fourni avec fils de suspensions en acier réglables et câble d'alimentation L= 2mt. Driver externe inclus. Patère et branchement électrique exclus, à commander séparément.



SOO ri 4000 K

Code	Diffuser	Size	Lumen Out*	Watt Tot	K	Beam angle	Driver Type	Driver Nr.	Colour
YSRI03N		01	1615	19	4000	D	ON/OFF	1	○
YSRI06N	OP: Opal	02	3400	40	4000	D	ON/OFF	1	○
YSRI10N		03	5700	67	4000	D	ON/OFF	1	○
YSRI12N	MP: Microprismatic	04	6848	82	4000	D	ON/OFF	1	○
YSRI15N		05	8500	100	4000	D	ON/OFF	1	○
YSRI17N		06	9350	110	4000	D	ON/OFF	1	○

SOO ri 3000 K

Code	Diffuser	Size	Lumen Out*	Watt Tot	K	Beam angle	Driver Type	Driver Nr.	Colour
YSRI03W		01	1485	19	3000	D	ON/OFF	1	○
YSRI06W	OP: Opal	02	3130	40	3000	D	ON/OFF	1	○
YSRI10W		03	5250	67	3000	D	ON/OFF	1	○
YSRI12W	MP: Microprismatic	04	6300	82	3000	D	ON/OFF	1	○
YSRI15W		05	7820	100	3000	D	ON/OFF	1	○
YSRI17W		06	8600	110	3000	D	ON/OFF	1	○

*Output flux with opal diffuser. With microprismatic diffuser + 10%

SOO ri STANDARD COLOUR SELECTION

● **WI** | White Irazu ● **BLL** | Black Lava

SOO ri ON REQUEST COLOUR SELECTION

● **BF** | Beige Futuna ● **SB** | Silver Bombalai ● **GK** | Gold Karkar
 ● **BL** | Bronze Lario ● **RR** | Rust Rame ● **BT** | Blue Telica

SOO ri BEAM ANGLE | DIMENSIONS

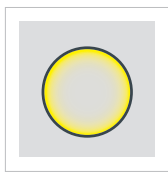

Size	X* [mm]	Y [mm]	Z [mm]	Kg
01	∅ 300	50	10	0,8
02	∅ 600	50	10	1,7
03	∅ 1000	50	10	2,8
04	∅ 1200	50	10	3,4
05	∅ 1500	50	10	4,5
06	∅ 1750	50	10	5,0

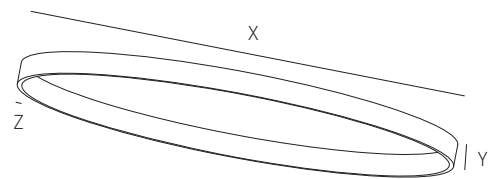

*Customizable diameters between ∅ 300mm and ∅ 1700mm

Min and Max room temperature: -20°+45° C.

SOO ACCESSORIES

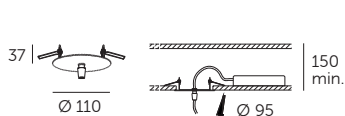

KT10301 + ○ COLOUR

Rose ceiling for installation with ceiling panel, remote driver.

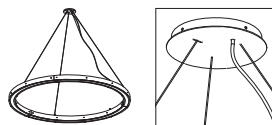

YSR-KRO230 + ○ COLOUR (max 60W)

∅ 230 H45

YSR-KRO290 + ○ COLOUR (max 110W)

∅ 290 H45

Rose ceiling for brick installation with driver housing.

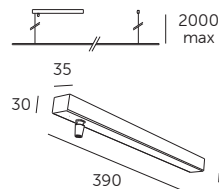

YKT10401 + ○ COLOUR

Rose ceiling for brick installation with driver housing.

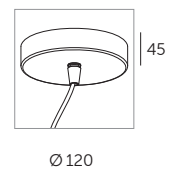

YKT10402 + ○ COLOUR

Rose ceiling for brick installation with driver housing.





Arrotondo



Arrondo d

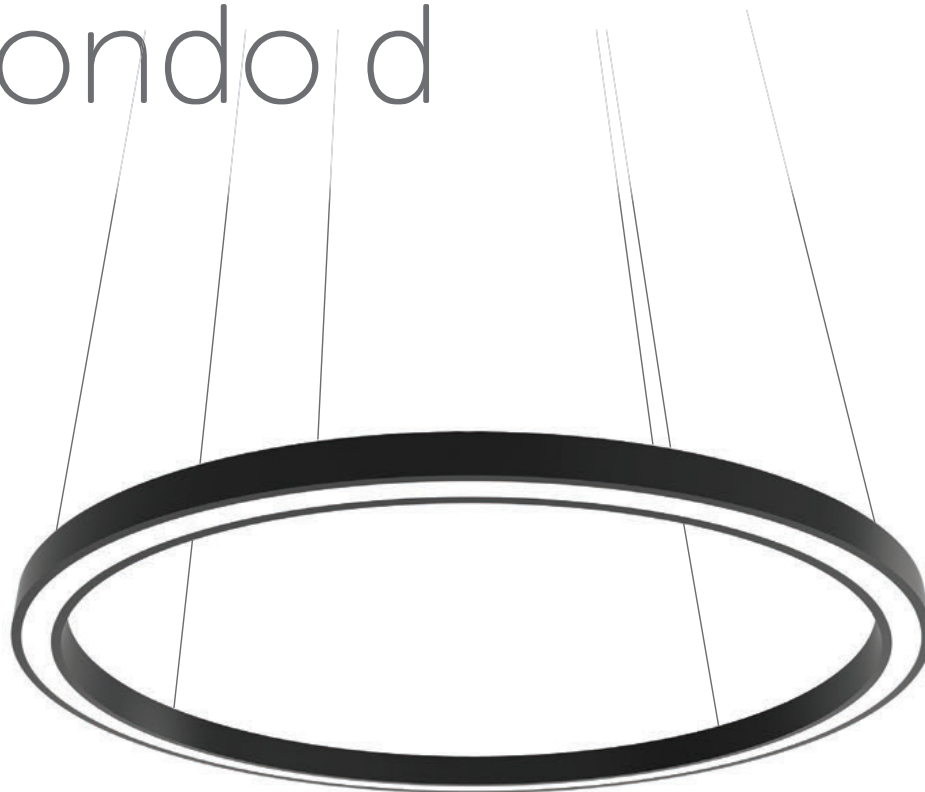

Decorative suspension / ceiling lighting fitting

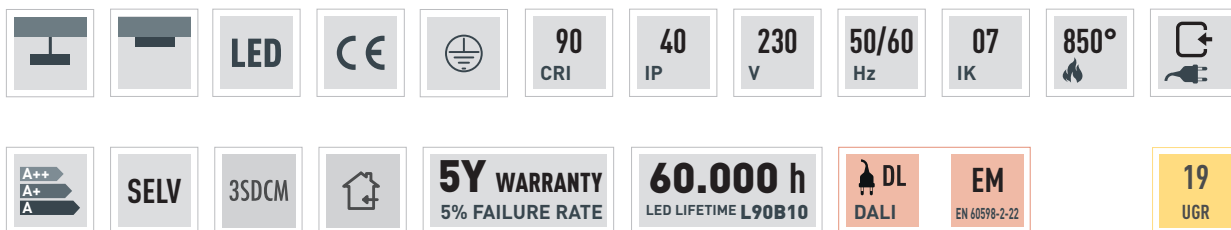

On request

Only for cod. MP

IT

Apparecchio decorativo per installazione a sospensione o plafone con accessorio fornito separatamente. Corpo in acciaio al carbonio calandrato e pressopiegato. Sorgente luminosa LED multichip diretta. Verniciatura con polveri epossidiche antigraffio. Schermo di chiusura in policarbonato microprismato UGR 19 (cod. MP), opale (cod. OP). Alimentatore incorporato. Rosone per collegamento elettrico non incluso, da ordinare separatamente.

ES

Luminaria decorativa de suspensión o de techo con accesorio suministrado por separado. Cuerpo de acero al carbono plegado y calandrado. Fuente de iluminación LED directa. Barnizado con polvo epoxi anti-rayado. Difusor de policarbonato opal (código OP), microprismato UGR19 (código MP). Balasto integrado. Roseta electrificada no incluida, a pedir por separada.

EN

Decorative suspension or ceiling lighting fitting, mounting accessory to be ordered separately. Bent and calendered carbon steel body. Direct multichip LED light source. Painted with scratch-resistant epoxy powders. Opal polycarbonate diffuser (code OP), microprismatic UGR 19 (code MP). Built-in driver. Rose ceiling for electrical connection not included, to be ordered separately.

DE

Dekoratives Hänge- und Deckenbeleuchtungsgerät, mit separat erhältlichem Zubehör. Körper aus kalandriertem und pressgeformtem Kohlenstoffstahl Direkte LED-Lichtquelle. Lackiert mit kratzfesten Epoxidpulvern. Diffusor aus opalem Polycarbonat (Kode OP), mikroprismatisch UGR 19 (Kode MP). Integrierter Treiber. Rosette für elektrischen Anschluss nicht enthalten, separat zu bestellen.

FR

Luminaire décoratif pour installation en suspension, ou plafond avec accessoire fourni séparément. Corps en acier au carbone plié à la presse et calandré. Source lumineuse LED multichip directe. Finition de peinture en poudre époxy anti-rayures. Diffuseur en polycarbonate opal (réf. OP), microprismé UGR 19 (réf. MP) Alimentation avec driver intégré. Patère et branchement électrique exclus, à commander séparément.

Arrondo d



ARRONDO d 4000 K

Code	Diffuser	Size	Lumen Out*	Watt Tot	K	Beam angle	Driver Type	Driver Nr.	Colour
YAR10N	OP: Opal	01	8350	83	4000	D	ON/OFF	1	○
YAR12N		02	10520	107	4000	D	ON/OFF	1	○
YAR15N	MP: Microprismatic	03	13700	139	4000	D	ON/OFF	1	○
YAR20N		04	18225	181	4000	D	ON/OFF	1	○
YAR30N		05	27335	271	4000	D	ON/OFF	1	○

ARRONDO d 3000 K

Code	Diffuser	Size	Lumen Out*	Watt Tot	K	Beam angle	Driver Type	Driver Nr.	Colour
YAR10W	OP: Opal	01	7735	83	3000	D	ON/OFF	1	○
YAR12W		02	9740	107	3000	D	ON/OFF	1	○
YAR15W	MP: Microprismatic	03	12685	139	3000	D	ON/OFF	1	○
YAR20W		04	16875	181	3000	D	ON/OFF	1	○
YAR30W		05	25310	271	3000	D	ON/OFF	1	○

*Output flux with opal diffuser. With microprismatic diffuser + 10%

ARRONDO d STANDARD COLOUR SELECTION

● **WI** | White Irazu ● **BLL** | Black Lava

ARRONDO d ON REQUEST COLOUR SELECTION

● **BF** | Beige Futuna ● **SB** | Silver Bombalai ● **GK** | Gold Karkar
● **BL** | Bronze Lario ● **RR** | Rust Rame ● **BT** | Blue Telica

ARRONDO d BEAM ANGLE | DIMENSIONS

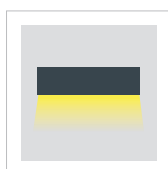

Size	X [mm]	Y [mm]	Z [mm]	Kg
01	∅ 1000	100	80	11,0
02	∅ 1200	100	80	13,0
03	∅ 1500	100	80	16,5
04	∅ 2000	100	80	26,0
05	∅ 3000	100	100	39,0

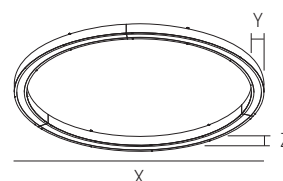

Min and Max room temperature: -20°+45° C.

ARRONDO d ACCESSORIES

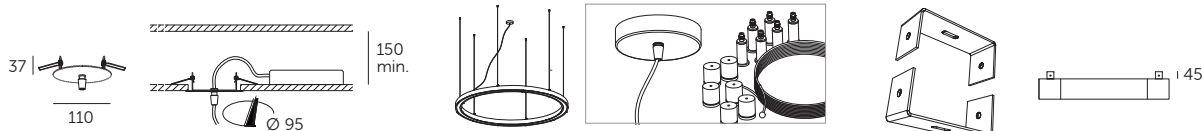

KT10301 + ○ COLOUR

Rose ceiling for installation with ceiling panel.

YKT35 + ○ COLOUR (size 01-02)

3 suspension cables, lenght: 2 mt*

YKT45 + ○ COLOUR (size 03-04)

4 suspension cables, lenght: 2 mt*

YKT65 + ○ COLOUR (size 05)

6 suspension cables, lenght: 2 mt*

YKTP35 + ○ COLOUR (size 01-02)

3 brackets for ceiling installation (H45 mm)

YKTP45 + ○ COLOUR (size 03-04)

4 brackets for ceiling installation (H45 mm)

YKTP65 + ○ COLOUR (size 05)

6 brackets for ceiling installation (H45 mm)

*Rose ceiling for brick installation ∅ 120 mm H25 mm

Arrondo di



Decorative suspension / ceiling lighting fitting

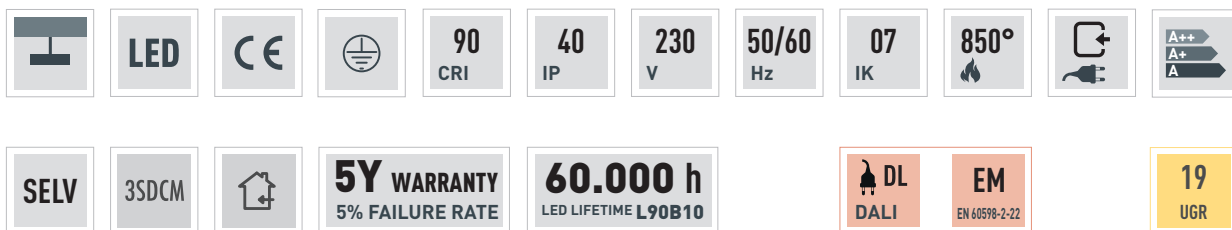

On request

Only for cod. MP

IT

Apparecchio decorativo per installazione a sospensione o plafone con accessorio fornito separatamente. Corpo in acciaio al carbonio calandrato e pressopiegato. Sorgente luminosa LED multichip diretta e indiretta. Verniciatura con polveri epossidiche antigraffio. Schermo di chiusura in policarbonato microprismato UGR 19 (cod. MP), opale (cod. OP). Alimentatore incorporato. Rosone per collegamento elettrico non incluso, da ordinare separatamente.

ES

Luminaria decorativa de suspensión o de techo con accesorio suministrado por separado. Cuerpo de acero al carbono plegado y calandrado. Fuente de iluminación LED directa y indirecta. Barnizado con polvo epoxi anti-rayado. Difusor de policarbonato opal (código OP), microprismato UGR19 (código MP). Balasto integrado. Roseta electrificada no incluida, a pedir por separada.

EN

Decorative suspension or ceiling lighting fitting, mounting accessory to be ordered separately. Bent and calendered carbon steel body. Direct and indirect multichip LED light source. Painted with scratch-resistant epoxy powders. Opal polycarbonate diffuser (code OP), microprismatic UGR 19 (code MP). Built-in driver. Rose ceiling for electrical connection not included, to be ordered separately.

DE

Dekoratives Hänge- und Deckenbeleuchtungsgerät, mit separat erhältlichem Zubehör. Körper aus kalandriertem und pressgeformtem Kohlenstoffstahl Direkte und indirekte LED-Lichtquelle. Lackiert mit kratzfesten Epoxidpulvern. Diffusor aus opalem Polycarbonat (Kode OP), mikroprismatisch UGR 19 (Kode MP). Integrierter Treiber. Rosette für elektrischen Anschluss nicht enthalten, separat zu bestellen.

FR

Luminaire décoratif pour installation en suspension, ou plafond avec accessoire fourni séparément. Corps en acier au carbone plies à la presse et calandré. Source lumineuse LED multichip directe et indirecte. Finition de peinture en poudre époxy anti-rayures. Diffuseur en polycarbonate opal (réf. OP), microprismé UGR 19 (réf. MP). Alimentation avec driver intégré. Patère et branchement électrique exclus, à commander séparément.

Arrondo di



ARRONDO di 4000 K

Code	Diffuser	Size	Lumen Out*	Watt Tot	K	Beam angle	Driver Type	Driver Nr.	Colour
YARI10N	OP: Opal	01	d 8350 + i 5012	133	4000	D	ON/OFF	1	○
YARI12N		02	d 10520 + i 6311	171	4000	D	ON/OFF	1	○
YARI15N	MP: Microprismatic	03	d 13700 + i 8220	223	4000	D	ON/OFF	1	○
YARI20N		04	d 18225 + i 10935	290	4000	D	ON/OFF	1	○
YARI30N		05	d 27335 + i 16400	434	4000	D	ON/OFF	1	○

ARRONDO di 3000 K

Code	Diffuser	Size	Lumen Out*	Watt Tot	K	Beam angle	Driver Type	Driver Nr.	Colour
YARI10W	OP: Opal	01	d 7735 + i 4641	133	3000	D	ON/OFF	1	○
YARI12W		02	d 9740 + i 5844	171	3000	D	ON/OFF	1	○
YARI15W	MP: Microprismatic	03	d 12685 + i 7611	223	3000	D	ON/OFF	1	○
YARI20W		04	d 16875 + i 10125	290	3000	D	ON/OFF	1	○
YARI30W		05	d 25310+ i 15186	434	3000	D	ON/OFF	1	○

*Output flux with opal diffuser. With microprismatic diffuser + 10%

ARRONDO di STANDARD COLOUR SELECTION

● WI | White Irazu ● BLL | Black Lava

ARRONDO di ON REQUEST COLOUR SELECTION

● BF | Beige Futuna ● SB | Silver Bombalai ● GK | Gold Karkar
● BL | Bronze Lario ● RR | Rust Rame ● BT | Blue Telica

ARRONDO di BEAM ANGLE | DIMENSIONS

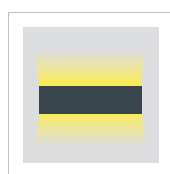

Size	X [mm]	Y [mm]	Z [mm]	Kg
01	∅ 1000	100	80	11,0
02	∅ 1200	100	80	13,0
03	∅ 1500	100	80	16,5
04	∅ 2000	100	80	26,0
05	∅ 3000	100	100	39,0

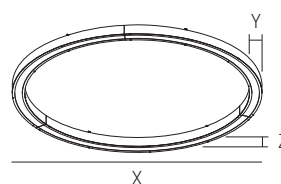

Min and Max room temperature: -20°+45° C.

ARRONDO ACCESSORIES

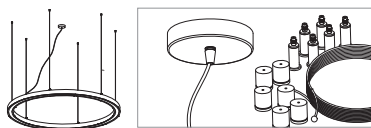
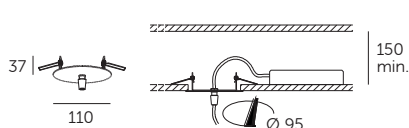

KT10301 + ○ COLOUR

Rose ceiling for installation with ceiling panel, remote driver.

YKT35 + ○ COLOUR (size 01-02)

3 suspension cables, lenght: 2 mt*

YKT45 + ○ COLOUR (size 03-04)

4 suspension cables, lenght: 2 mt*

YKT65 + ○ COLOUR (size 05)

6 suspension cables, lenght: 2 mt*

*Rose ceiling for brick installation ∅ 120 mm H25 mm





Round



Round d



Decorative suspension / ceiling lighting fitting

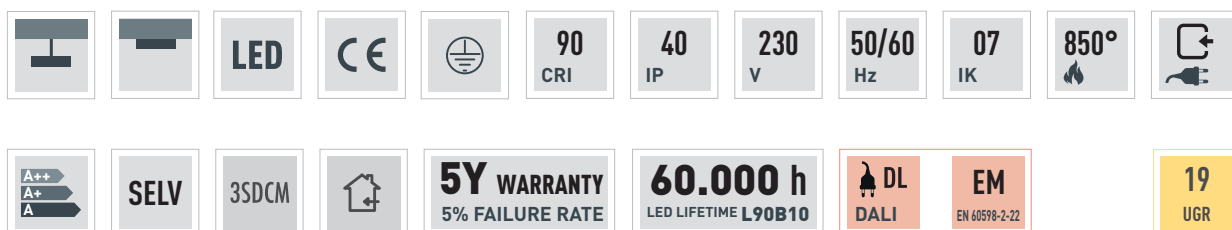

On request

Only for cod. MP

IT

Apparecchio decorativo per installazione a sospensione o plafone con accessorio fornito separatamente. Corpo in alluminio tornito. Sorgente luminosa LED multichip diretta. Verniciatura con polveri epossidiche antigraffio. Schermo di chiusura in policarbonato microprismato UGR 19 (cod. MP), opale (cod. OP). Alimentatore incorporato. Rosone per collegamento elettrico non incluso, da ordinare separatamente.

ES

Luminaria decorativa de suspensión o de techo con accesorio suministrado por separado. Cuerpo en aluminio torneado. Fuente de iluminación LED directa. Barnizado con polvo epoxi anti-rayado. Difusor de policarbonato opal (código OP), microprismato UGR19 (código MP). Balasto integrado. Roseta electrificada no incluida, a pedir por separada..

EN

Decorative suspension or ceiling lighting fitting, mounting accessory to be ordered separately. Turned aluminum body. Direct multichip LED light source. Painted with scratch-resistant epoxy powders. Opal polycarbonate diffuser (code OP), microprismatic UGR 19 (code MP). Built-in driver. Rose ceiling for electrical connection not included, to be ordered separately.

DE

Dekoratives Hänge- und Deckenbeleuchtungsgerät, mit separat erhältlichem Zubehör. Körper aus gedrehtem Aluminium. Direkte LED-Lichtquelle. Lackiert mit kratzfesten Epoxidpulvern. Diffusor aus opalem Polycarbonat (Kode OP), mikroprismatisch UGR 19 (Kode MP). Integrierter Treiber. Rosette für elektrischen Anschluss nicht enthalten, separat zu bestellen.

FR

Luminaire décoratif pour installation en suspension, ou plafond avec accessoire fourni séparément. Corps en aluminium tourné. Source lumineuse LED multichip directe. Finition de peinture en poudre époxy anti-rayures. Diffuseur en polycarbonate opal (réf. OP), microprismé UGR 19 (réf. MP). Alimentation avec driver intégré. Patère et branchement électrique exclus, à commander séparément.

Round d



01



02



03



04

ROUND d 4000 K

Code	Diffuser	Size	Lumen Out*	Watt Tot	K	Beam angle	Driver Type	Driver Nr.	Colour
YRO27N	OP: Opal	01	1043	13	4000	D	ON/OFF	1	○
YRO36N		02	1710	21	4000	D	ON/OFF	1	○
YRO55N	MP: Microprismatic	03	10060	87	4000	D	ON/OFF	1	○
YRO75N		04	16765	145	4000	D	ON/OFF	1	○

ROUND d 3000 K

Code	Diffuser	Size	Lumen Out*	Watt Tot	K	Beam angle	Driver Type	Driver Nr.	Colour
YRO27W	OP: Opal	01	966	13	3000	D	ON/OFF	1	○
YRO36W		02	1583	21	3000	D	ON/OFF	1	○
YRO55W	MP: Microprismatic	03	9314	87	3000	D	ON/OFF	1	○
YRO75W		04	15523	145	3000	D	ON/OFF	1	○

*Output flux with opal diffuser. With microprismatic diffuser + 10%

ROUND d STANDARD COLOUR SELECTION

● **WI** | White Irazu

● **BLL** | Black Lava

ROUND d ON REQUEST COLOUR SELECTION

● **BF** | Beige Futuna

● **SB** | Silver Bombalai

● **GK** | Gold Karkar

● **BL** | Bronze Lario

● **RR** | Rust Rame

● **BT** | Blue Telica

ROUND d BEAM ANGLE | DIMENSIONS

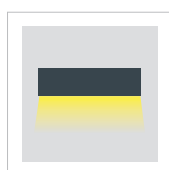

Size	X [mm]	Z [mm]	Kg
01	∅ 270	90	2,7
02	∅ 360	90	3,7
03	∅ 550	110	5,8
04	∅ 750	110	8,0

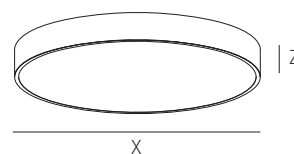

Min and Max room temperature: -20°+45° C.

ROUND ACCESSORIES



YKT35 + ○ COLOUR

Rose ceiling for brick installation Ø 120 mm H 25 mm
3 suspension cables, lenght: 2 mt.

Round di



Decorative suspension lighting fitting

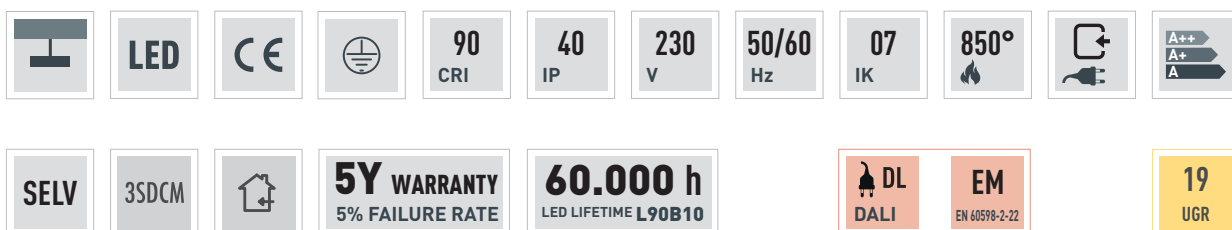

On request

Only for cod. MP

IT

Apparecchio decorativo per installazione a sospensione. Corpo in alluminio tornito. Sorgente luminosa LED multichip diretta e indiretta. Verniciatura con polveri epossidiche antigraffio. Schermo di chiusura in policarbonato microprismato UGR 19 (cod. MP), opale (cod. OP). Alimentatore incorporato. Rosone per collegamento elettrico non incluso, da ordinare separatamente.

ES

Luminaria decorativa de suspensión. Cuerpo en aluminio torneado. Fuente de iluminación LED directa y indirecta. Barnizado con polvo epoxi anti-rayado. Difusor de policarbonato opal (código OP), microprismato UGR19 (código MP). Balasto integrado. Roseta electrificada no incluida, a pedir por separada.

EN

Decorative suspension lighting fitting, mounting. Turned aluminum body. Direct and indirect multichip LED light source. Painted with scratch-resistant epoxy powders. Opal polycarbonate diffuser (code OP), microprismatic UGR 19 (code MP). Built-in driver. Rose ceiling for electrical connection not included, to be ordered separately.

DE

Dekoratives Hängebeleuchtungsgerät. Körper aus gedrehtem Aluminium. Direkte und indirekte LED-Lichtquelle. Lackiert mit kratzfesten Epoxidpulvern. Diffusor aus opalem Polycarbonat (Kode OP), mikroprismatisch UGR 19 (Kode MP). Integrierter Treiber. Rosette für elektrischen Anschluss nicht enthalten, separat zu bestellen.

FR

Appareil décoratif en suspension. Corps en aluminium tourné. Source lumineuse LED multichip directe et indirecte. Finition de peinture en poudre époxy anti-rayures. Diffuseur en polycarbonate opal (réf. OP), microprismé UGR 19 (réf. MP). Alimentation avec driver intégré. Patère et branchement électrique exclus, à commander séparément.

Round di



01



02



03

ROUND di 4000 K

Code	Diffuser	Size	Lumen Out*	Watt Tot	K	Beam angle	Driver Type	Driver Nr.	Colour
YROI36N	OP: Opal	01	d 1710 + i 1135	34	4000	D	ON/OFF	1	○
YROI55N	MP: Microprismatic	02	d 10060 + i 1890	80	4000	D	ON/OFF	1	○
YROI75N	MP: Microprismatic	03	d 16765 + i 1890	134	4000	D	ON/OFF	1	○

ROUND di 3000 K

Code	Diffuser	Size	Lumen Out*	Watt Tot	K	Beam angle	Driver Type	Driver Nr.	Colour
YROI36W	OP: Opal	01	d 1583 + i 1050	34	3000	D	ON/OFF	1	○
YROI55W	MP: Microprismatic	02	d 9314 + i 1750	80	3000	D	ON/OFF	1	○
YROI75W	MP: Microprismatic	03	d 15523 + i 1750	134	3000	D	ON/OFF	1	○

*Output flux with opal diffuser. With microprismatic diffuser + 10%

ROUND di STANDARD COLOUR SELECTION

● **WI** | White Irazu

● **BLL** | Black Lava

ROUND di ON REQUEST COLOUR SELECTION

● **BF** | Beige Futuna

● **SB** | Silver Bombalai

● **GK** | Gold Karkar

● **BL** | Bronze Lario

● **RR** | Rust Rame

● **BT** | Blue Telica

ROUND di BEAM ANGLE | DIMENSIONS

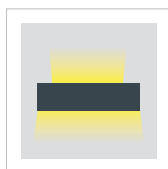

Size	X [mm]	Z [mm]	Kg
01	∅ 360	90	3,7
02	∅ 550	110	5,8
03	∅ 750	110	8,0

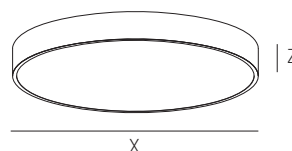

Min and Max room temperature: -20°+45° C.

ROUND ACCESSORIES



YKT35 + ○ COLOUR

Rose ceiling for brick installation ∅ 120 mm H 25 mm
3 suspension cables, lenght: 2 mt.





Round IP55



Round IP55



Decorative suspension / ceiling lighting fitting

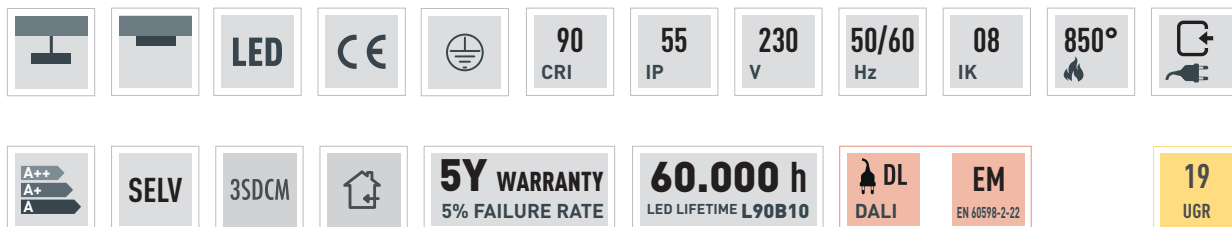

On request

Only for cod. MP

IT

Apparecchio decorativo per installazione a sospensione o plafone con accessorio fornito separatamente. Corpo in acciaio al carbonio calandrato e pressopiegato. Sorgente luminosa LED multichip diretta. Verniciatura con polveri epossidiche antigraffio. Schermo di chiusura in policarbonato micropismatico UGR 19 (cod. MP), opale (cod. OP). Alimentatore incorporato. Rosone per collegamento elettrico non incluso, da ordinare separatamente.

ES

Luminaria decorativa de suspensión o de techo con accesorio suministrado por separado. Cuerpo de acero al carbono plegado y calandrado. Fuente de iluminación LED directa. Barnizado con polvo epoxi anti-rayado. Difusor de policarbonato opal (código OP), micropismatico UGR19 (código MP). Balasto integrado. Roseta electrificada no incluida, a pedir por separada.

EN

Decorative suspension or ceiling lighting fitting, mounting accessory to be ordered separately. Bent and calendered carbon steel body. Direct multichip LED light source. Painted with scratch-resistant epoxy powders. Opal polycarbonate diffuser (code OP), microprismatic UGR 19 (code MP). Built-in driver. Rose ceiling for electrical connection not included, to be ordered separately.

DE

Dekoratives Hänge- und Deckenbeleuchtungsgerät, mit separat erhältlichem Zubehör. Körper aus kalandriertem und pressgeformtem Kohlenstoffstahl. Direkte LED-Lichtquelle. Lackiert mit kratzfesten Epoxidpulvern. Diffusor aus opalem Polycarbonat (Kode OP), mikroprismatisch UGR 19 (Kode MP). Integrierter Treiber. Rosette für elektrischen Anschluss nicht enthalten, separat zu bestellen.

FR

Luminaire décoratif pour installation en suspension, ou plafond avec accessoire fourni séparément. Corps en acier au carbone plies à la presse et calandré. Source lumineuse LED multichip directe. Finition de peinture en poudre époxy anti-rayures. Diffuseur en polycarbonate opal (réf. OP), microprismé UGR 19 (réf. MP). Alimentation avec driver intégré. Patère et branchement électrique exclus, à commander séparément.

Round IP55



01



02



03

ROUND ip55 4000 K

Code	Diffuser	Size	Lumen Out*	Watt Tot	K	Beam angle	Driver Type	Driver Nr.	Colour
YRO60N	OP: Opal	01	9200	80	4000	D	ON/OFF	1	○
YRO90N		02	15220	131	4000	D	ON/OFF	1	○
YRO120N	MP: Microprismatic	03	20570	175	4000	D	ON/OFF	1	○

ROUND ip55 3000 K

Code	Diffuser	Size	Lumen Out*	Watt Tot	K	Beam angle	Driver Type	Driver Nr.	Colour
YRO60W	OP: Opal	01	8520	80	3000	D	ON/OFF	1	○
YRO90W		02	14090	131	3000	D	ON/OFF	1	○
YRO120W	MP: Microprismatic	03	19050	175	3000	D	ON/OFF	1	○

*Output flux with opal diffuser. With microprismatic diffuser + 10%

ROUND ip55 STANDARD COLOUR SELECTION

● **WI** | White Irazu ● **BLL** | Black Lava

ROUND ip55 ON REQUEST COLOUR SELECTION

● **BF** | Beige Futuna ● **SB** | Silver Bombalai ● **GK** | Gold Karkar
● **BL** | Bronze Lario ● **RR** | Rust Rame ● **BT** | Blue Telica

ROUND ip55 BEAM ANGLE | DIMENSIONS

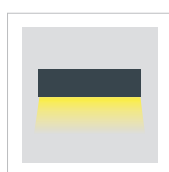

Size	X [mm]	Z [mm]	Kg
01	∅ 600	150	10,0
02	∅ 900	150	20,5
03	∅ 1200	150	38,0

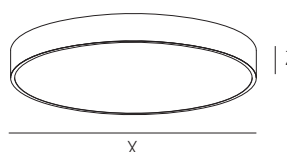

Min and Max room temperature: -20°+45° C.

ROUND ACCESSORIES



KIT YKT45

YKT45 + ○ COLOUR

Rose ceiling for brick installation ∅ 120 mm H 25 mm
4 suspension cables, lenght: 2 mt.





Ufo



Ufo



Decorative suspension lighting fitting

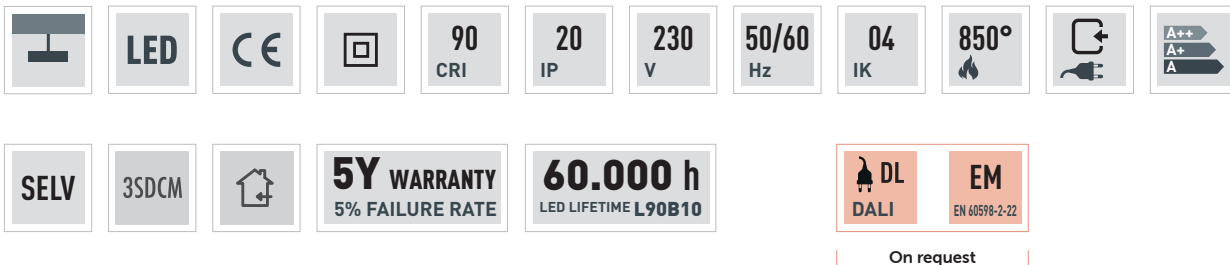

IT

Apparecchio decorativo per installazione a sospensione.
Corpo in alluminio tornito.
Sorgente luminosa a LED (lampada E27).
Verniciatura con polveri epossidiche antigraffio.

EN

Decorative suspension lighting fitting.
Turned aluminum body.
LED light source (lamp E27).
Painted with scratch-resistant epoxy powders.

FR

Appareil décoratif en suspension.
Corps en aluminium tourné.
Source lumineuse LED (Lampe E27).
Finition de peinture en poudre époxy anti-rayures.

ES

Luminaria decorativa de suspensión.
Cuerpo en aluminio torneado.
Fuente de iluminación con LED (lámpara E27).
Barnizado con polvo epoxi anti-rayado.

DE

Dekoratives Hängebeleuchtungsgerät.
Körper aus gedrehtem Aluminium.
Leuchtmittel mit LED (Leuchte E27).
Lackierung mit kratzfesten Epoxypulvern.



UFO

Code	Size	Lumen Out	Watt Tot	K	Beam angle	Driver Type	Driver	Colour
YUF01W	01	2100	23	W	D	ON/OFF	1	○

UFO STANDARD COLOUR SELECTION

● **WI** | White Irazu ● **BLL** | Black Lava

UFO ON REQUEST COLOUR SELECTION

● **BF** | Beige Futuna ● **SB** | Silver Bombalai ● **GK** | Gold Karkar
 ● **BL** | Bronze Lario ● **RR** | Rust Rame ● **BT** | Blue Telica

UFO BEAM ANGLE | DIMENSIONS



Size	X [mm]	Z [mm]	Kg
01	Ø 500	95	1.2

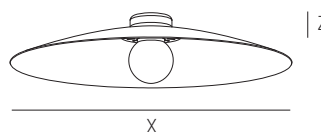

Min and Max room temperature: -20°+45° C.

UFO INSTALLATION FEATURES



Rose ceiling for brick installation Ø 120 mm H 25 mm
 with suspension cable, lenght: 2 mt included.



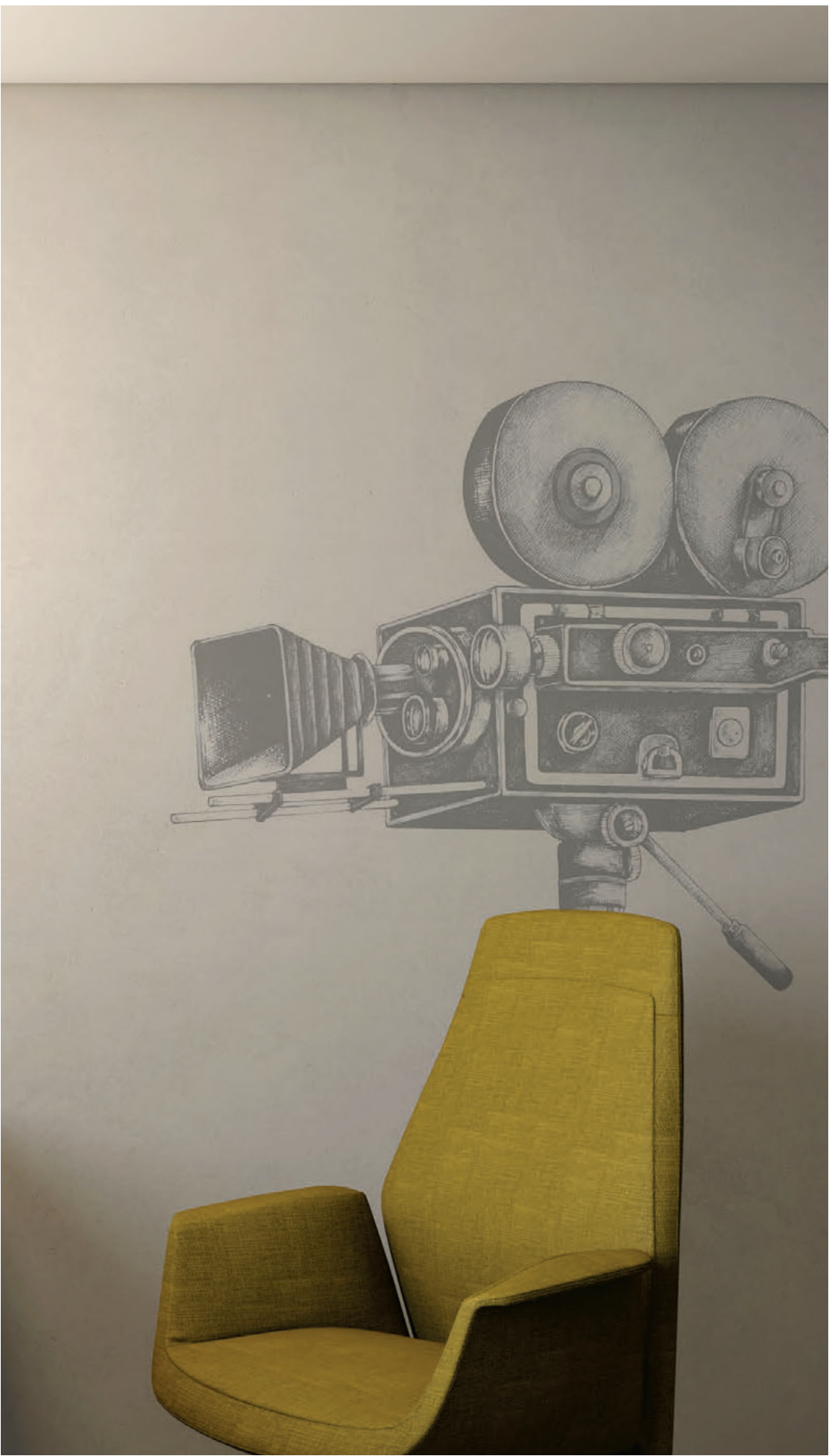

Circo



Circo



Decorative suspension lighting fitting

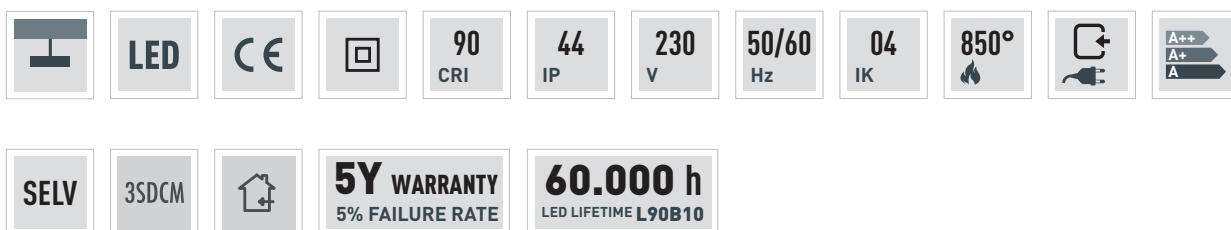

IT

Apparecchio decorativo per installazione a sospensione. Corpo in alluminio estruso calandrato. Sorgente luminosa LED multichip interna. Verniciatura con polveri epossidiche antigraffio. Schermo di chiusura in silicone opale. Alimentatore incorporato.

ES

Luminaria decorativa de suspensión. Cuerpo en aluminio extruido calandrado. Fuente de iluminación LED multichip interno. Recubierta con polvo epoxi antirayado. Difusor de silicona opal. Balasto integrado.

EN

Decorative suspension lighting fitting. Calendered extruded aluminum body. Multichip LED lighting source internal. Antiscratch epoxy powder paint finish. Opal silicone closing reflector. Built-in driver.

DE

Dekoratives Hängebeleuchtungsgerät. Körper aus kalandriertem und extrudiertem Kohlenstoffstahl. Interne multichip LED-Lichtquelle. Lackierung mit kratzfesten Epoxypulvern. Opalabdeckschirm aus Silikon. Integrierter Treiber.

FR

Appareil décoratif en suspension. Corps en aluminium extrudé et calandré. Source de lumière en LED multichip interne. Finition de peinture en poudre époxyanti-rayures. Écran de fermeture en silicone opale. Alimentation avec driver intégré.

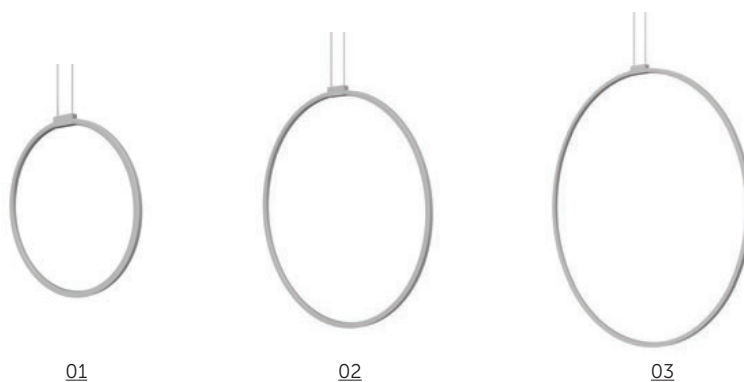

CIRCO 4000 K

Code	Size	Lumen Out	Watt Tot	K	Beam angle	Driver Type	Driver	Colour
YCI32N	01	2430	21	4000	D	ON/OFF	1	○
YCI48N	02	3630	31	4000	D	ON/OFF	1	○
YCI64N	03	4845	41	4000	D	ON/OFF	1	○

CIRCO 3000 K

Code	Size	Lumen Out	Watt Tot	K	Beam angle	Driver Type	Driver	Colour
YCI32W	01	2250	21	3000	D	ON/OFF	1	○
YCI48W	02	3360	31	3000	D	ON/OFF	1	○
YCI64W	03	4485	41	3000	D	ON/OFF	1	○

CIRCO STANDARD COLOUR SELECTION

● **WI** | White Irazu ● **BLL** | Black Lava

CIRCO ON REQUEST COLOUR SELECTION

● **BF** | Beige Futuna ● **SB** | Silver Bombalai ● **GK** | Gold Karkar
 ● **BL** | Bronze Lario ● **RR** | Rust Rame ● **BT** | Blue Telica

CIRCO BEAM ANGLE | DIMENSIONS

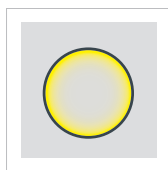

Size	X (mm)	Y (mm)	Z (mm)	Kg
01	∅ 325	12	Max 2000	0,5
02	∅ 485	12	Max 2000	0,7
03	∅ 645	12	Max 2000	0,9

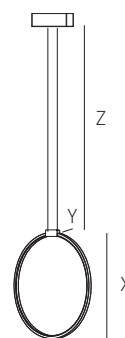

Min and Max room temperature: -20°+45° C.

CIRCO INSTALLATION FEATURES

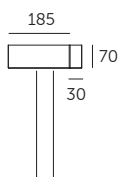

Rose ceiling for brick installation ∅ 185 x 27 x H 67 mm
 2 suspension cables, lenght: 2 mt included.





Olimpia



Olimpia

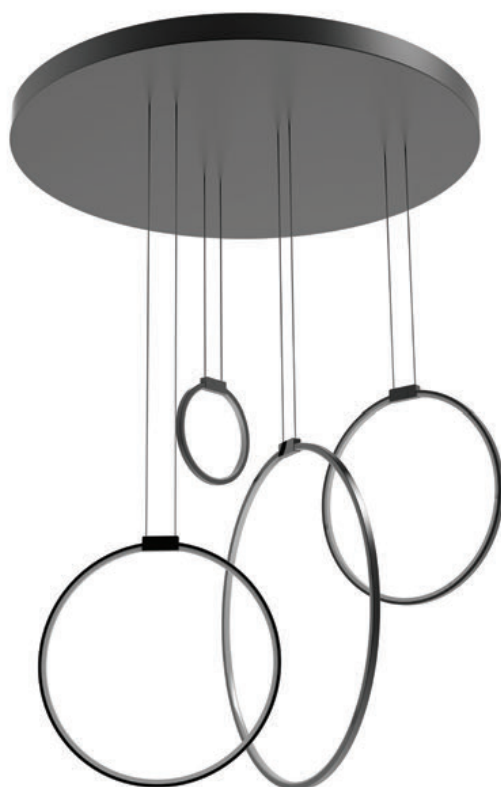

Decorative suspension lighting fitting

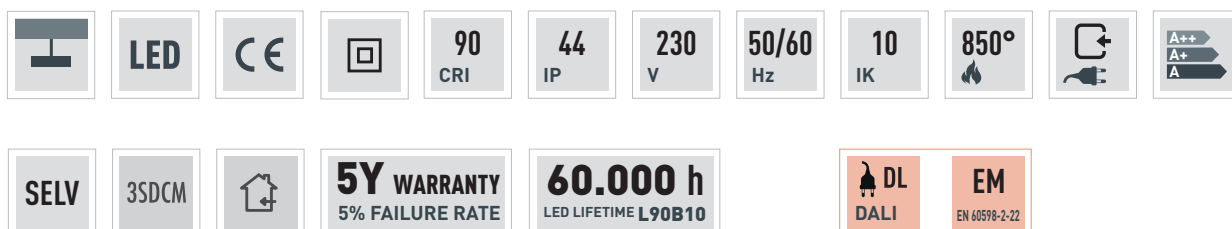

On request

IT

Apparecchio decorativo per installazione a sospensione. Base superiore in acciaio al carbonio. Corpo apparecchio in alluminio estruso calandrato. Sorgente luminosa LED multichip interna. Verniciatura con polveri epossidiche antigraffio. Schermo di chiusura in silicone opale. Alimentatore incorporato.

ES

Luminaria decorativa de suspensión. Base superior en acero al carbono. Cuerpo en aluminio extruido calandrado. Fuente de iluminación LED multichip interno. Recubierta con polvo epoxi antirayado. Difusor de silicona opal. Balasto integrado.

EN

Decorative suspension lighting fitting. Carbon steel upper base. Calandered extruded aluminum body. Internal multichip LED light source. Antiscratch epoxy powder paint finish. Opal silicone closing reflector. Built-in driver.

DE

Dekoratives Hängebeleuchtungsgerät. Obere Basis aus Kohlenstoffstahl. Körper aus kalandriertem und extrudiertem Kohlenstoffstahl. Interne multichip LED-Lichtquelle. Lackierung mit kratzfesten Epoxypulvern. Opalabdeckschirm aus Silikon. Integrierter Treiber.

FR

Appareil décoratif en suspension. Base supérieure en acier au carbone. Corps en aluminium extrudé et calandré. Source de lumière en LED multichip interne. Finition de peinture en poudre époxyanti-rayures. Écran de fermeture en silicone opale. Alimentation avec driver intégré.

Olimpia



OLIMPIA 4000 K

Code	Size	Lumen Out	Watt Tot	K	Beam angle	Driver Type	Driver	Colour
YOL58N	01	10050	85	4000	D	ON/OFF	1	○

OLIMPIA 3000 K

Code	Size	Lumen Out	Watt Tot	K	Beam angle	Driver Type	Driver	Colour
YOL58W	01	9250	85	3000	D	ON/OFF	1	○

OLIMPIA STANDARD COLOUR SELECTION

● **WI** | White Irazu ● **BLL** | Black Lava

OLIMPIA ON REQUEST COLOUR SELECTION

● **BF** | Beige Futuna ● **SB** | Silver Bombalai ● **GK** | Gold Karkar
 ● **BL** | Bronze Lario ● **RR** | Rust Rame ● **BT** | Blue Telica

OLIMPIA BEAM ANGLE | DIMENSIONS

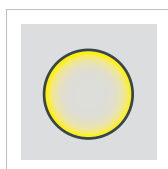

Size	X [mm]	Y [mm]	Z [mm]	K	Kg
01	ø 750	*	max 2000	40	9

* Y [mm]:

1= ø 165	2= ø 325	3= ø 325	4= ø

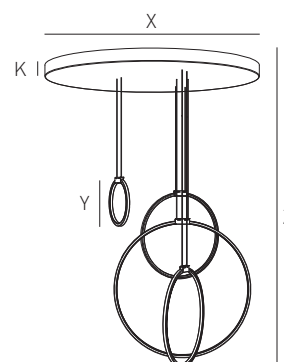

Min and Max room temperature: -20°+45° C.

OLIMPIA SPECIAL FEATURES

On request: special configuration to be agreed with technical offices.





Aquaadro



Aquadro

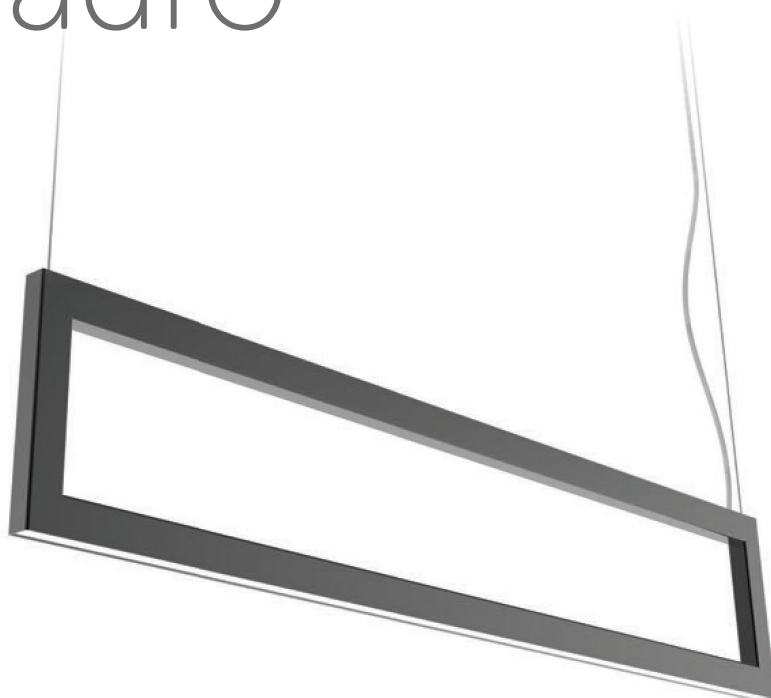

Decorative suspension lighting fitting



On request

Only for cod. MP

IT

Apparecchio decorativo per installazione a sospensione. Corpo in acciaio al carbonio pressopiegato. Sorgente luminosa LED multichip diretta e indiretta. Verniciatura con polveri epossidiche antigraffio. Diffusore in policarbonato opale (cod. OP), microprismato UGR 19 (cod. MP). Fornito completo di sospensioni in acciaio regolabili e cavo di alimentazione L=2m. Alimentatore incluso esterno. Rosone per collegamento elettrico non incluso, da ordinare separatamente.

ES

Luminaria decorativa de suspensión. Cuerpo de acero al carbono plegado. Fuente de iluminación LED directa y indirecta. Barnizado con polvo epoxi anti-rayado. Difusor de policarbonato opal (código OP), microprismato UGR19 (código MP). Cables de suspensión de acero ajustables y cable de alimentación L=2m incluidos. Balasto externo incluido. Roseta electrificada no incluida, a pedir por separada.

EN

Decorative suspension lighting fitting. Bent carbon steel body. Direct and indirect LED light source. Painted with scratch-resistant epoxy powders. Opal polycarbonate diffuser (code OP), microprismatic UGR 19 (code MP). Supplied complete with adjustable steel suspensions and power cable L = 2m. External driver included. Rose ceiling for electrical connection not included, to be ordered separately.

DE

Dekoratives Hängebeleuchtungsgerät. Körper aus pressgeformtem Kohlenstoffstahl. Direkte und indirekte LED-Lichtquelle. Lackiert mit kratzfesten Epoxidpulvern. Diffusor aus opalem Polycarbonat (Kode OP), mikroprismatisch UGR 19 (Kode MP). Komplett mit verstellbaren Stahlhängungen und Netzkabel L = 2m. Externer elektronischer Treiber enthalten. Deckenbefestigung für elektrische Verbindung nicht enthalten, separat zu bestellen.

FR

Appareil décoratifs en suspension. Corps en acier au carbone plies à la presse. Source lumineuse LED directe et indirecte. Finition de peinture en poudre époxy anti-rayures. Diffuseur en polycarbonate opal (réf. OP), microprismé UGR 19 (réf. MP). Fourni avec fils de suspensions en acier réglables et câble d'alimentation L= 2mt Driver externe inclus. Patère et branchement électrique exclus, à commander séparément.

Aquadro

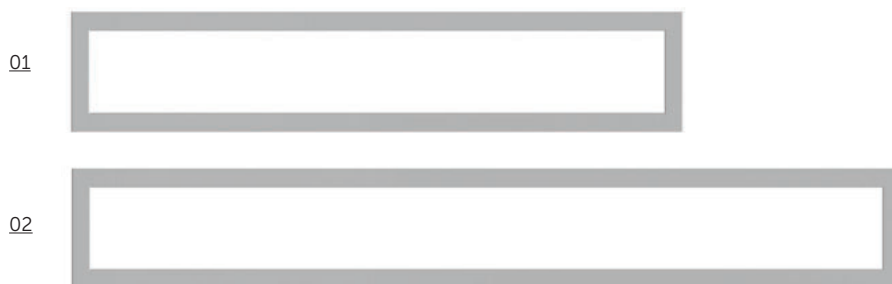

AQUADRO 4000 K

Code	Diffuser	Size	Lumen Out*	Watt Tot	K	Beam angle	Driver Type	Driver Nr.	Colour
YAQ11N	OP: Opal	01	6267	51	4000	D	ON/OFF	1	○
YAQ15N	MP: Microprismatic	02	8546	69	4000	D	ON/OFF	1	○

AQUADRO 3000 K

Code	Diffuser	Size	Lumen Out*	Watt Tot	K	Beam angle	Driver Type	Driver Nr.	Colour
YAQ11W	OP: Opal	01	5803	51	3000	D	ON/OFF	1	○
YAQ15W	MP: Microprismatic	02	7913	69	3000	D	ON/OFF	1	○

*Output flux with opal diffuser. With microprismatic diffuser + 10%

AQUADRO STANDARD COLOUR SELECTION

● **WI** | White Irazu ● **BLL** | Black Lava

AQUADRO ON REQUEST COLOUR SELECTION

● **BF** | Beige Futuna ● **SB** | Silver Bombalai ● **GK** | Gold Karkar
● **BL** | Bronze Lario ● **RR** | Rust Rame ● **BT** | Blue Telica

AQUADRO BEAM ANGLE | DIMENSIONS

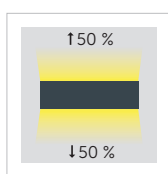

Size	X [mm]	Y [mm]	Z [mm]	Kg
01	1130	27	220	3,8
02	1530	27	220	5,0

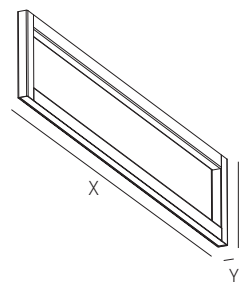

Min and Max room temperature: -20°+45° C.

AQUADRO ACCESSORIES

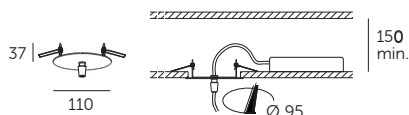

KT10301 + ○ COLOUR

Rose ceiling for installation with ceiling panel, remote driver.

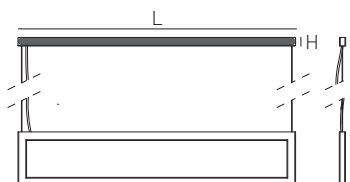

YAQ11-KRO (L 1130) + ○ COLOUR

YAQ15-KRO (L 1530) + ○ COLOUR

Rose ceiling for brick installation H45 mm with driver housing.

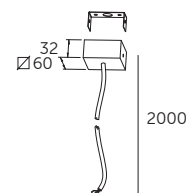

KT10501 + ○ COLOUR

Rose ceiling for brick installation without driver housing for remote driver.





ELIOT
TOIJE



Eliot



Decorative suspension lighting fitting

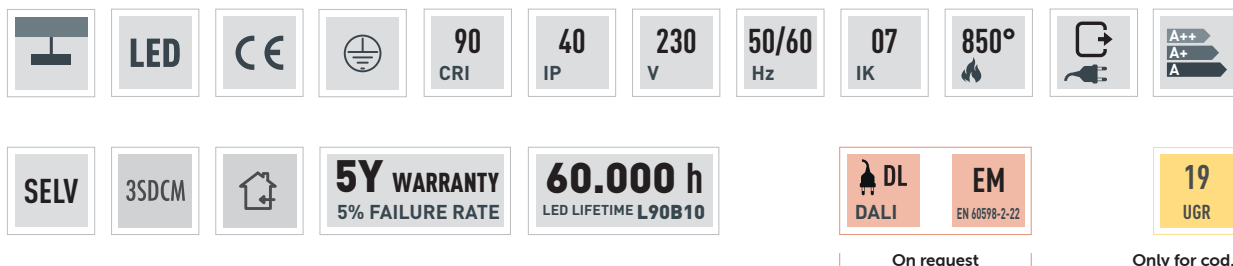

On request

Only for cod. MP

IT

Apparecchio decorativo per installazione a sospensione. Corpo in acciaio al carbonio pressopiegato. Sorgente luminosa LED multichip diretta. Verniciatura con polveri epossidiche antigraffio. Diffusore in policarbonato opale (cod. OP), microprismato UGR 19 (cod. MP). Fornito completo di sospensioni in acciaio regolabili e cavo di alimentazione L=2m. Alimentatore incluso esterno. Rosone per collegamento elettrico non incluso, da ordinare separatamente.

ES

Luminaria decorativa de suspensión. Cuerpo de acero al carbono plegado. Fuente de iluminación LED directa. Barnizado con polvo epoxi anti-rayado. Difusor de policarbonato opal (código OP), microprismato UGR19 (código MP). Cables de suspensión de acero ajustables y cable de alimentación L=2m incluidos. Balasto externo incluido. Roseta electrificada no incluida, a pedir por separada.

EN

Decorative suspension lighting fitting. Bent carbon steel body. Direct LED light source. Painted with scratch-resistant epoxy powders. Opal polycarbonate diffuser (code OP), microprismatic UGR 19 (code MP). Supplied complete with adjustable steel suspensions and power cable L = 2m. External driver included. Rose ceiling for electrical connection not included, to be ordered separately.

DE

Dekoratives Hängebeleuchtungsgerät. Körper aus pressgeformtem Kohlenstoffstahl. Direkte LED-Lichtquelle. Lackiert mit kratzfesten Epoxidpulvern. Diffusor aus opalem Polycarbonat (Kode OP), mikroprismatisch UGR 19 (Kode MP). Komplett mit verstellbaren Stahlabhängungen und Netzkabel L = 2m. Externer elektronischer Treiber enthalten. Deckenbefestigung für elektrische Verbindung nicht enthalten, separat zu bestellen.

FR

Appareil décoratifs en suspension. Corps en acier au carbone plies à la presse. Source lumineuse LED directe. Finition de peinture en poudre époxy anti-rayures. Diffuseur en polycarbonate opal (réf. OP), microprismé UGR 19 (réf. MP). Fourni avec fils de suspensions en acier réglables et câble d'alimentation L= 2m Driver externe inclus. Patère et branchement électrique exclus, à commander séparément.

01



02



ELIOT 4000 K

Code	Diffuser	Size	Lumen Out*	Watt Tot	K	Beam angle	Driver Type	Driver Nr.	Colour
YEL11N	OP: Opal	01	6267	51	4000	D	ON/OFF	1	○
YEL15N	MP: Microprismatic	02	8546	69	4000	D	ON/OFF	1	○

ELIOT 3000 K

Code	Diffuser	Size	Lumen Out*	Watt Tot	K	Beam angle	Driver Type	Driver Nr.	Colour
YEL11W	OP: Opal	01	5803	51	3000	D	ON/OFF	1	○
YEL15W	MP: Microprismatic	02	7913	69	3000	D	ON/OFF	1	○

*Output flux with opal diffuser. With microprismatic diffuser + 10%

ELIOT STANDARD COLOUR SELECTION

● **WI** | White Irazu ● **BLL** | Black Lava

ELIOT ON REQUEST COLOUR SELECTION

● **BF** | Beige Futuna ● **SB** | Silver Bombalai ● **GK** | Gold Karkar
 ● **BL** | Bronze Lario ● **RR** | Rust Rame ● **BT** | Blue Telica

ELIOT BEAM ANGLE | DIMENSIONS



Size	X [mm]	Y [mm]	Z [mm]	Kg
01	1130	205	27	3,6
02	1530	205	27	4,8

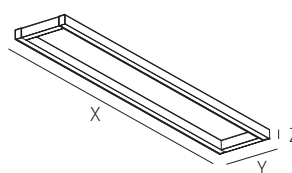

Min and Max room temperature: -20°+45° C.

ELIOT ACCESSORIES

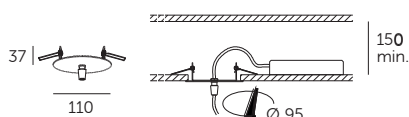

KT10301 + ○ COLOUR

Rose ceiling for installation with ceiling panel, remote driver.

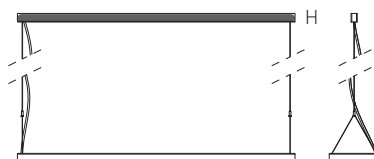

YEL11-KRO (L 1130) + ○ COLOUR

YEL15-KRO (L 1530) + ○ COLOUR

Rose ceiling for brick installation H45 mm with driver housing.

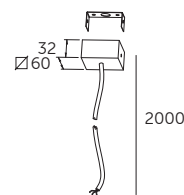

KT10501 + ○ COLOUR

Rose ceiling for brick installation without driver housing.





Nori



Nori



Decorative suspension lighting fitting

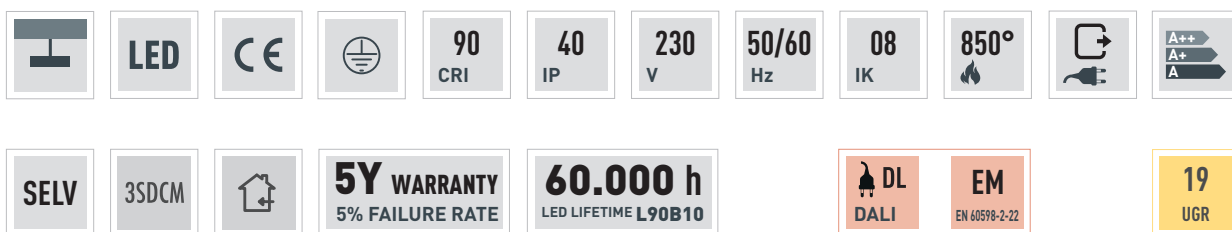

On request

Only for cod. MP

IT

Apparecchio decorativo per installazione a sospensione. Corpo in acciaio al carbonio pressopiegato. Sorgente luminosa LED multichip diretta. Verniciatura con polveri epossidiche antigraffio. Diffusore in policarbonato opale (cod. OP), microprismato UGR 19 (cod. MP). Fornito completo di sospensioni in acciaio regolabili e cavo di alimentazione L=2m. Alimentatore incluso esterno. Rosone per collegamento elettrico non incluso, da ordinare separatamente.

ES

Luminaria decorativa de suspensión. Cuerpo de acero al carbono plegado. Fuente de iluminación LED directa. Barnizado con polvo epoxi anti-rayado. Difusor de policarbonato opal (código OP), microprismato UGR19 (código MP). Cables de suspensión de acero ajustables y cable de alimentación L=2m incluidos. Balasto externo incluido. Roseta electrificada no incluida, a pedir por separada.

EN

Decorative suspension lighting fitting. Bent carbon steel body. Direct LED light source. Painted with scratch-resistant epoxy powders. Opal polycarbonate diffuser (code OP), microprismatic UGR 19 (code MP). Supplied complete with adjustable steel suspensions and power cable L = 2m. External driver included. Rose ceiling for electrical connection not included, to be ordered separately.

DE

Dekoratives Hängebeleuchtungsgerät. Körper aus pressgeformtem Kohlenstoffstahl. Direkte LED-Lichtquelle. Lackiert mit kratzfesten Epoxidpulvern. Diffusor aus opalem Polycarbonat (Kode OP), mikroprismatisch UGR 19 (Kode MP). Komplett mit verstellbaren Stahlabhängungen und Netzkabel L = 2m. Externer elektronischer Treiber enthalten. Deckenbefestigung für elektrische Verbindung nicht enthalten, separat zu bestellen.

FR

Appareil décoratifs en suspension. Corps en acier au carbone plies à la presse. Source lumineuse LED directe. Finition de peinture en poudre époxy anti-rayures. Diffuseur en polycarbonate opal (réf. OP), microprismé UGR 19 (réf. MP). Fourni avec fils de suspensions en acier réglables et câble d'alimentation L = 2mt. Driver externe inclus. Patère et branchement électrique exclus, à commander séparément.

01



02



NORI 4000 K

Code	Diffuser	Size	Lumen Out*	Watt Tot	K	Beam angle	Driver Type	Driver Nr.	Colour
YNR11N	OP: Opal	01	3133	25	4000	D	ON/OFF	1	○
YNR15N	MP: Microprismatic	02	4272	35	4000	D	ON/OFF	1	○

NORI 3000 K

Code	Diffuser	Size	Lumen Out*	Watt Tot	K	Beam angle	Driver Type	Driver Nr.	Colour
YNR11W	OP: Opal	01	2901	25	3000	D	ON/OFF	1	○
YNR15W	MP: Microprismatic	02	3956	35	3000	D	ON/OFF	1	○

*Output flux with opal diffuser. With microprismatic diffuser + 10%

NORI STANDARD COLOUR SELECTION

● **WI** | White Irazu ● **BLL** | Black Lava

NORI ON REQUEST COLOUR SELECTION

● **BF** | Beige Futuna ● **SB** | Silver Bombalai ● **GK** | Gold Karkar
 ● **BL** | Bronze Lario ● **RR** | Rust Rame ● **BT** | Blue Telica

NORI BEAM ANGLE | DIMENSIONS



Size	X [mm]	Y [mm]	Z [mm]	Kg
01	1205	27	35	1,2
02	1605	27	35	1,6

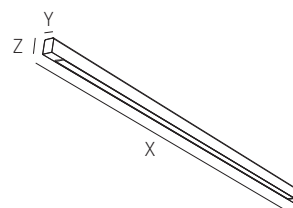

Min and Max room temperature: -20°+45° C.

NORI ACCESSORIES

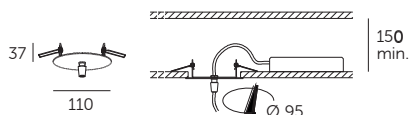

KT10301 + ○ COLOUR

Rose ceiling for installation with ceiling panel, remote driver.

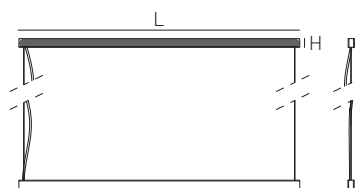

YNR11-KRO (L 1205) + ○ COLOUR

YNR15-KRO (L 1605) + ○ COLOUR

Rose ceiling for brick installation H45 mm with driver housing.

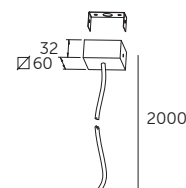

KT10501 + ○ COLOUR

Rose ceiling for brick installation without driver housing.





’É
E
J
E



Jeè

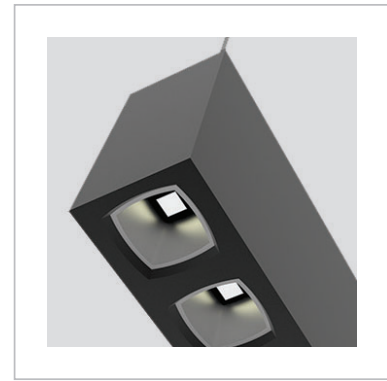
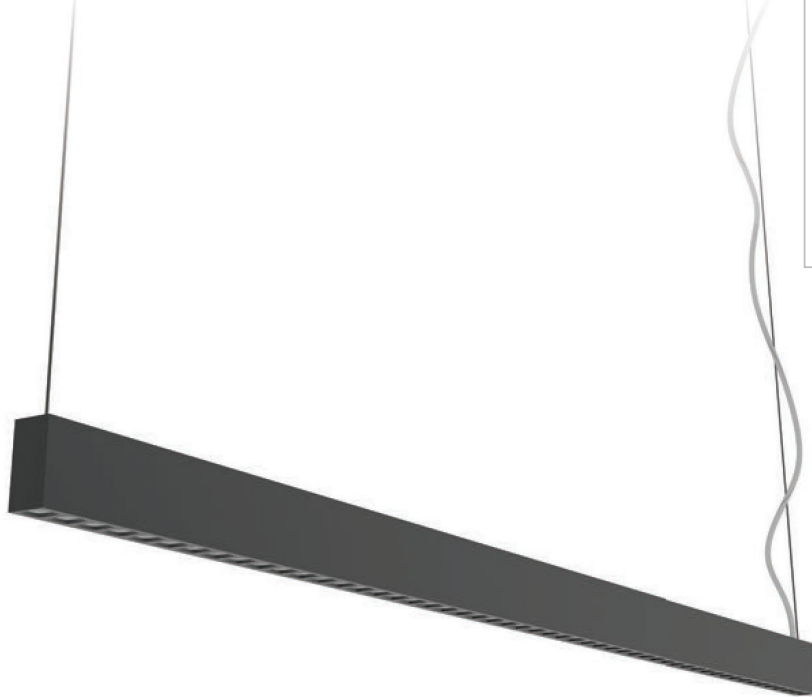

Decorative suspension lighting fitting



On request

Only for cod. MP

IT

Apparecchio decorativo per installazione a sospensione. Corpo in acciaio al carbonio pressopiegato. Sorgente luminosa LED multichip diretta. Micro ottiche in policarbonato alluminato. Verniciatura con polveri epossidiche antigraffio. Diffusore in policarbonato opale (cod. OP), microprismato UGR 19 (cod. MP). Fornito completo di sospensioni in acciaio regolabili e cavo di alimentazione L=2m. Alimentatore incluso esterno. Rosone per collegamento elettrico non incluso, da ordinare separatamente.

EN

Decorative suspension lighting fitting. Bent carbon steel body. Direct LED light source. Micro optics in aluminized polycarbonate. Painted with scratch-resistant epoxy powders. Opal polycarbonate diffuser (code OP), microprismatic UGR 19 (code MP). Supplied complete with adjustable steel suspensions and power cable L = 2m. External driver included. Rose ceiling for electrical connection not included, to be ordered separately.

FR

Appareil décoratifs en suspension. Corps en acier au carbone plies à la presse. Source lumineuse LED directe. Microprismé dans le polycarbonate d'aluminium. Finition de peinture en poudre époxy anti-rayures. Diffuseur en polycarbonate opal (réf. OP), microprismé UGR 19 (réf. MP). Fourni avec fils de suspensions en acier réglables et câble d'alimentation L= 2mt Driver externe inclus. Patère et branchement électrique exclus, à commander séparément.

ES

Luminaria decorativa de suspensión. Cuerpo de acero al carbono plegado. Fuente de iluminación LED directa. Micro ópticas en policarbonato aluminizado. Barnizado con polvo epoxi anti-rayado. Difusor de policarbonato opal (código OP), microprismato UGR19 (código MP). Cables de suspensión de acero ajustables y cable de alimentación L=2m incluidos. Balasto externo incluido. Roseta electrificada no incluida, a pedir por separada.

DE

Dekoratives Hängebeleuchtungsgerät. Körper aus pressgeformtem Kohlenstoffstahl. Direkte LED-Lichtquelle. Mikrooptik aus aluminisiertem Polycarbonat. Lackiert mit kratzfesten Epoxidpulvern. Diffusor aus opalem Polycarbonat (Kode OP), mikroprismatisch UGR 19 (Kode MP). Komplett mit verstellbaren Stahlabhängungen und Netzkabel L = 2m. Externer elektronischer Treiber enthalten. Deckenbefestigung für elektrische Verbindung nicht enthalten, separat zu bestellen.

01

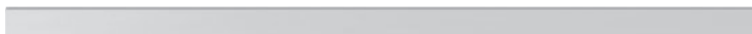

02



JEÈ 4000 K

Code	Size	Lumen Out	Watt Tot	K	Beam angle	Driver Type	Driver	Colour
YJE11N	01	2765	27,5	4000	D	ON/OFF	1	○
YJE15N	02	3510	34,5	4000	D	ON/OFF	1	○

JEÈ 3000 K

Code	Size	Lumen Out	Watt Tot	K	Beam angle	Driver Type	Driver	Colour
YJE11W	01	2560	27,5	3000	D	ON/OFF	1	○
YJE15W	02	3250	34,5	3000	D	ON/OFF	1	○

JEÈ STANDARD COLOUR SELECTION

● **WI** | White Irazu ● **BLL** | Black Lava

JEÈ ON REQUEST COLOUR SELECTION

● **BF** | Beige Futuna ● **SB** | Silver Bombalai ● **GK** | Gold Karkar
 ● **BL** | Bronze Lario ● **RR** | Rust Rame ● **BT** | Blue Telica

JEÈ BEAM ANGLE | DIMENSIONS



Size	X (mm)	Y (mm)	Z (mm)	Kg
01	1140	26	53	2,0
02	1425	26	53	2,8

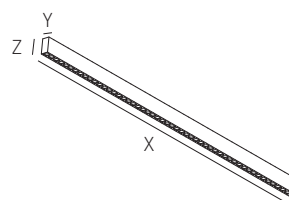

Min and Max room temperature: -20°+45° C.

JEÈ ACCESSOIRES

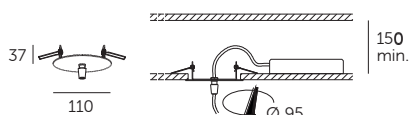

KT10301 + ○ COLOUR

Rose ceiling for installation with ceiling panel, remote driver.



YJE11-KRO (L 1140) + ○ COLOUR

YJE15-KRO (L 1425) + ○ COLOUR

Rose ceiling for brick installation H45 mm with driver housing.

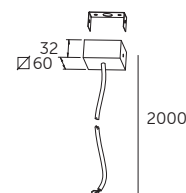

KT10501 + ○ COLOUR

Rose ceiling for brick installation without driver housing.





Squak



Squak d



Decorative suspension lighting fitting



On request

Only for cod. MP

IT

Apparecchio decorativo per installazione a sospensione. Corpo in alluminio estruso. Sorgente luminosa LED multichip diretta. Micro ottiche in policarbonato alluminato. Verniciatura con polveri epossidiche antigraffio. Diffusore in policarbonato opale (cod. OP), microprismato UGR 19 (cod. MP). Fornito completo di rosone con collegamento elettrico, alimentatore incorporato, 4 cavi di sospensione in acciaio regolabili e cavo di alimentazione L=2m.

ES

Luminaria decorativa de suspensión. Cuerpo en aluminio extruido. Fuente de iluminación LED directa. Micro ópticas en policarbonato aluminizado. Barnizado con polvo epoxi anti-rayado. Difusor de policarbonato opal (código OP), microprismato UGR19 (código MP). Roseta electrificada, balasto integrado, 4 cables de suspensión de acero ajustables y cable de alimentación L=2m incluidos.

EN

Decorative suspension lighting fitting. Extruded aluminium body. Direct LED light source. Micro optics in aluminized polycarbonate. Painted with scratch-resistant epoxy powders. Opal polycarbonate diffuser (code OP), microprismatic UGR 19 (code MP). Supplied complete with rose ceiling for electrical connection, integrated driver, 4 adjustable steel suspensions and power cable L = 2m.

DE

Dekoratives Hängebeleuchtungsgerät. Körper aus extrudiertem Kohlenstoffstahl. Direkte LED-Lichtquelle. Mikrooptik aus aluminisiertem Polycarbonat Lackiert mit kratzfesten Epoxidpulvern. Diffusor aus opalem Polycarbonat (Kode OP), mikroprismatisch UGR 19 (Kode MP). Komplett mit Deckenbefestigung für elektrische Verbindung, Integrierter Treiber und 4 verstellbaren Stahlhängungen und Netzkabel L = 2m.

FR

Appareil décoratifs en suspension. Corps en aluminium extrudé. Source lumineuse LED directe. Microprismé dans le polycarbonate d'aluminium. Finition de peinture en poudre époxy anti-rayures Diffuseur en polycarbonate opal (réf. OP), microprismé UGR 19 (réf. MP) Fourni avec patère et branchement électrique, alimentation avec driver intégré, 4 filins de suspensions en acier réglables et câble d'alimentation L= 2mt.

Squak d

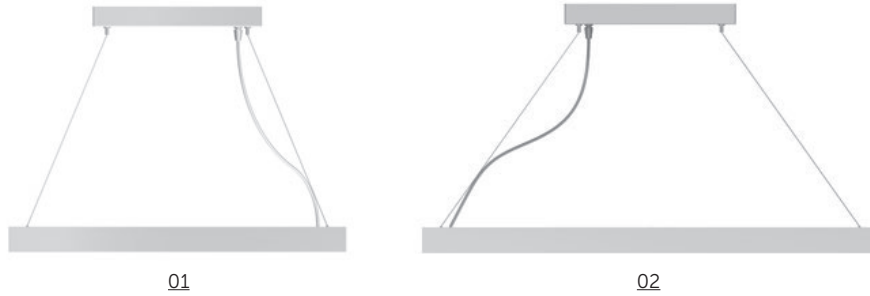

SQUAK d 4000 K

Code	Diffuser	Size	Lumen Out*	Watt Tot	K	Beam angle	Driver Type	Driver Nr.	Colour
YSQD60N	OP: Opal	01	5182	55	4000	D	ON/OFF	1	○
YSQD80N	MP: Microprismatic	02	7671	74	4000	D	ON/OFF	1	○

SQUAK d 3000 K

Code	Diffuser	Size	Lumen Out*	Watt Tot	K	Beam angle	Driver Type	Driver Nr.	Colour
YSQD60W	OP: Opal	01	4788	55	3000	D	ON/OFF	1	○
YSQD80W	MP: Microprismatic	02	7103	74	3000	D	ON/OFF	1	○

*Output flux with opal diffuser. With microprismatic diffuser + 10%

SQUAK d STANDARD COLOUR SELECTION

● **WI** | White Irazu ● **BLL** | Black Lava

SQUAK d ON REQUEST COLOUR SELECTION

● **BF** | Beige Futuna ● **SB** | Silver Bombalai ● **GK** | Gold Karkar
● **BL** | Bronze Lario ● **RR** | Rust Rame ● **BT** | Blue Telica

SQUAK d BEAM ANGLE | DIMENSIONS

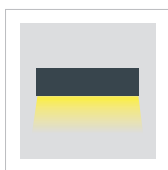

D

Min and Max room temperature: -20°+45° C.

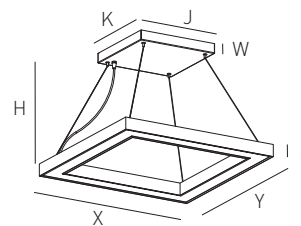

Size	X [mm]	Y [mm]	Z [mm]	K+J [mm]	W [mm]	H [mm]	Kg
01	600	600	45	300	40	500÷2000	5,8
02	800	800	45	300	40	500÷2000	7,8

SQUAK INSTALLATION FEATURES

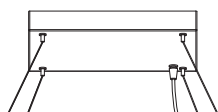

Rose ceiling for brick installation
(For dimension see above table) +
4 suspension cables, lenght: 2 mt included.

Squak di



Decorative suspension lighting fitting

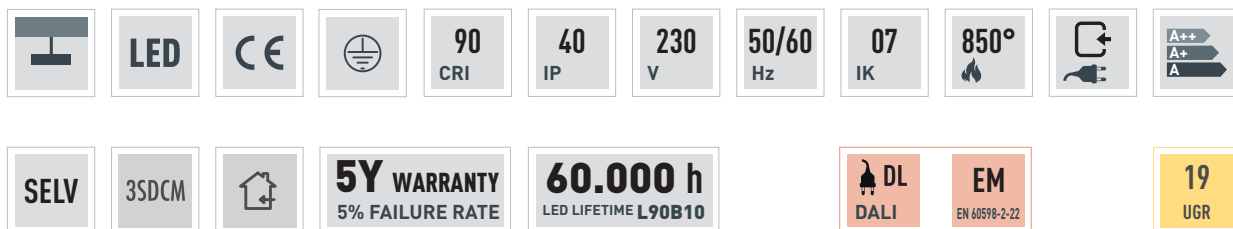

On request

Only for cod. MP

IT

Apparecchio decorativo per installazione a sospensione. Corpo in alluminio estruso. Sorgente luminosa LED multichip diretta e indiretta. Micro ottiche in policarbonato alluminato. Verniciatura con polveri epossidiche antigraffio. Diffusore in policarbonato opale (cod. OP), microprismato UGR 19 (cod. MP). Fornito completo di rosone con collegamento elettrico, alimentatore incorporato, 4 cavi di sospensione in acciaio regolabili e cavo di alimentazione L=2m.

ES

Luminaria decorativa de suspensión. Cuerpo en aluminio extruido. Fuente de iluminación LED directa y indirecta. Micro ópticas en policarbonato aluminizado. Barnizado con polvo epoxi anti-rayado. Difusor de policarbonato opal (código OP), microprismato UGR19 (código MP). Roseta electrificada, balasto integrado, 4 cables de suspensión de acero ajustables y cable de alimentación L=2m incluidos.

EN

Decorative suspension lighting fitting. Extruded aluminium body. Direct and indirect LED light source. Micro optics in aluminized polycarbonate. Painted with scratch-resistant epoxy powders. Opal polycarbonate diffuser (code OP), microprismatic UGR 19 (code MP). Supplied complete with rose ceiling for electrical connection, integrated driver, 4 adjustable steel suspensions and power cable L = 2m.

DE

Dekoratives Hängebeleuchtungsgerät. Körper aus extrudiertem Kohlenstoffstahl. Direkte und indirekte LED-Lichtquelle. Mikrooptik aus aluminisiertem Polycarbonat Lackiert mit kratzfesten Epoxidpulvern. Diffusor aus opalem Polycarbonat (Kode OP), mikroprismatisch UGR 19 (Kode MP). Komplett mit Deckenbefestigung für elektrische Verbindung, Integrierter Treiber und 4 verstellbaren. Stahlhängungen und Netzkabel L = 2m.

FR

Appareil décoratifs en suspension. Corps en aluminium extrudé. Source lumineuse LED directe et indirecte. Microprismé dans le polycarbonate d'aluminium. Finition de peinture en poudre époxy anti-rayures. Diffuseur en polycarbonate opal (réf. OP), microprismé UGR 19 (réf. MP). Fourni avec patère et branchement électrique, alimentation avec driver intégré, 4 fils de suspensions en acier réglables et câble d'alimentation L= 2mt.

Squak di

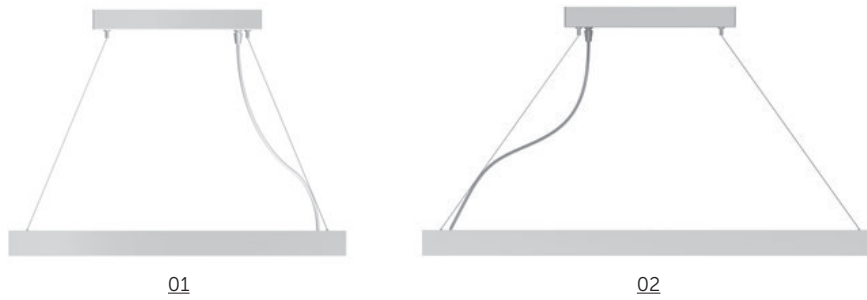

SQUAK di 4000 K

Code	Diffuser	Size	Lumen Out*	Watt Tot	K	Beam angle	Driver Type	Driver Nr.	Colour
YSQDI60N	OP: Opal	01	d 5182 + i 3053	55+29	4000	D	ON/OFF	1	○
YSQDI80N	MP: Microprismatic	02	d 7671 + i 3331	74+32	4000	D	ON/OFF	1	○

SQUAK di 3000 K

Code	Diffuser	Size	Lumen Out*	Watt Tot	K	Beam angle	Driver Type	Driver Nr.	Colour
YSQDI60W	OP: Opal	01	d 4798 + i 2827	55+29	3000	D	ON/OFF	1	○
YSQDI80W	MP: Microprismatic	02	d 7103 + i 3084	74+32	3000	D	ON/OFF	1	○

*Output flux with opal diffuser. With microprismatic diffuser + 10%

SQUAK di STANDARD COLOUR SELECTION

● **WI** | White Irazu ● **BLL** | Black Lava

SQUAK di ON REQUEST COLOUR SELECTION

● **BF** | Beige Futuna ● **SB** | Silver Bombalai ● **GK** | Gold Karkar
 ● **BL** | Bronze Lario ● **RR** | Rust Rame ● **BT** | Blue Telica

SQUAK di BEAM ANGLE | DIMENSIONS



D+I

Min and Max room temperature: -20°+45° C.

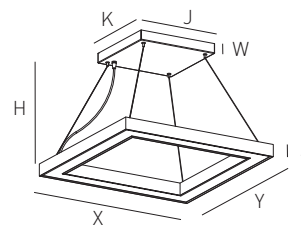

Size	X [mm]	Y [mm]	Z [mm]	K+J [mm]	W [mm]	H [mm]	Kg
01	600	600	45	300	40	500÷2000	5,8
02	800	800	45	300	40	500÷2000	7,8

SQUAK INSTALLATION FEATURES

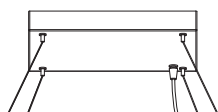

Rose ceiling for brick installation
 (For dimension see above table) +
 4 suspension cables, lenght: 2 mt included.





Addalppina



Adalpina



Decorative suspension lighting fitting

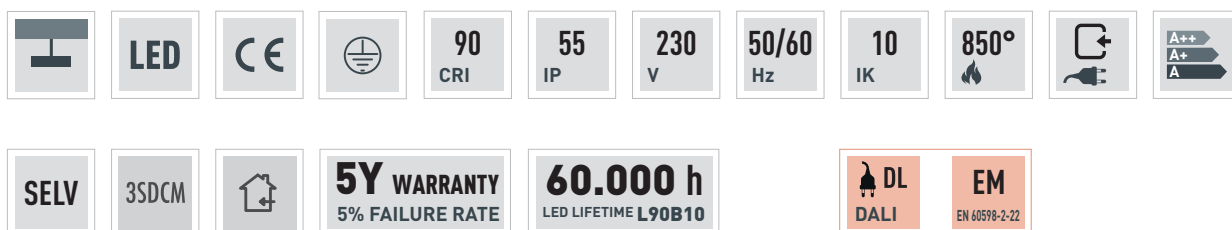

On request

IT

Apparecchio decorativo per installazione a sospensione. Vano alimentatore in alluminio estruso. Verniciatura con polveri epossidiche antigraffio. Corpo diffusore in policarbonato opale. Sorgente luminosa LED multichip. Alimentatore incorporato. Fornito completo di rosone con collegamento elettrico e cavo di alimentazione L=2m.

ES

Luminaria decorativa de suspensión. Compartimento de alimentación en aluminio extruido. Barnizado con polvo epoxi anti-rayado. Cuerpo difusor de policarbonato opal. Fuente de iluminación. Balasto integrado. Roseta electrificada y cable de alimentación L=2m incluidos.

EN

Decorative suspension lighting fitting. Extruded aluminium power supply compartment. Painted with scratch-resistant epoxy powders. Opal polycarbonate diffuser body. LED light source. Integrated driver. Supplied complete with rose ceiling for electrical connection and power cable L = 2m.

DE

Dekoratives Hängebeleuchtungsgerät. Feeder-Einheit aus extrudiertem Kohlenstoffstahl. Lackiert mit kratzfesten Epoxidpulvern. Diffusor Körper aus opalem Polycarbonat. LED-Lichtquelle. Integrierter Treiber. Komplett mit Deckenbefestigung für elektrische Verbindung und Netzkabel L = 2m.

ER

Appareil décoratifs en suspension. Patère en aluminium extrudé. Finition de peinture en poudre époxy anti-rayures. Corp diffuseur en polycarbonate opal. Source lumineuse LED. Alimentation avec driver intégré. Fourni avec patère et branchement électrique et câble d'alimentation L= 2mt.

Adalpina

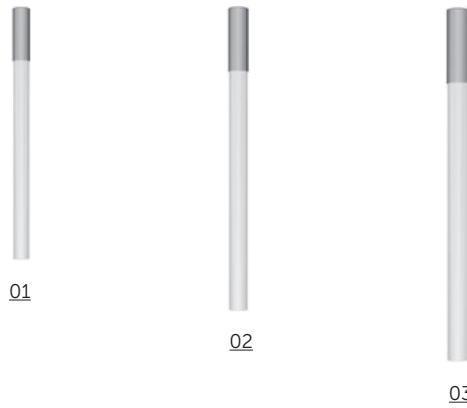

ADALPINA 4000 K

Code	Size	Lumen Out	Watt Tot	K	Beam angle	Driver Type	Driver	Colour
YAD13N	01	5803	46	4000	D	ON/OFF	1	○
YAD18N	02	7954	69	4000	D	ON/OFF	1	○
YAD23N	03	10606	92	4000	D	ON/OFF	1	○

ADALPINA 3000 K

Code	Size	Lumen Out	Watt Tot	K	Beam angle	Driver Type	Driver	Colour
YAD13W	01	4910	46	3000	D	ON/OFF	1	○
YAD18W	02	7365	69	3000	D	ON/OFF	1	○
YAD23W	03	9820	92	3000	D	ON/OFF	1	○

ADALPINA STANDARD COLOUR SELECTION

● **WI** | White Irazu ● **BLL** | Black Lava

ADALPINA ON REQUEST COLOUR SELECTION

● **BF** | Beige Futuna ● **SB** | Silver Bombalai ● **GK** | Gold Karkar
 ● **BL** | Bronze Lario ● **RR** | Rust Rame ● **BT** | Blue Telica

ADALPINA BEAM ANGLE | DIMENSIONS

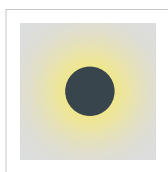

Size	X (mm)	Y (mm)	Z (mm)	K (mm)	J (mm)	Kg
01	ø 83	ø 90	1350	1000	350	3,2
02	ø 83	ø 90	1850	1500	350	4,5
03	ø 83	ø 90	2350	2000	350	5,8



EM VERSION:
Z / J + 200 mm

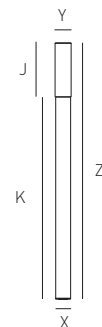

Min and Max room temperature: -20°+45° C.

ADALPINA INSTALLATION FEATURES

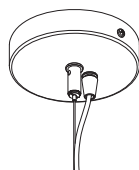

Rose ceiling for brick installation
 Ø Rose ceiling 120 mm | Height (25 mm)
 Suspension cable, lenght: 2 mt included.





Libora



Libra



Decorative suspension, ceiling and wall lighting fitting

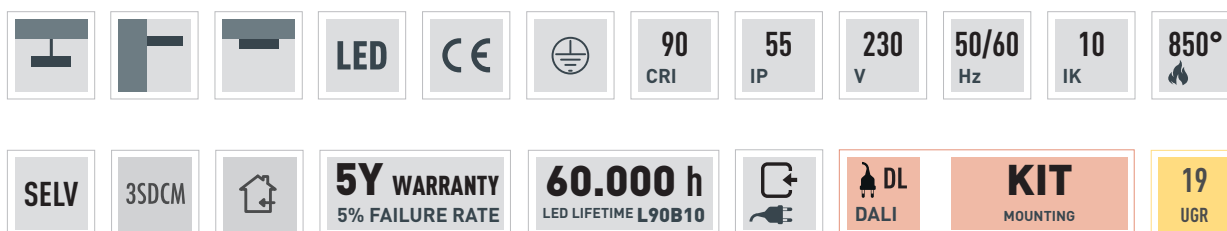

On request

IT

Apparecchio decorativo per installazione a sospensione, parete e plafone. Corpo diffusore in policarbonato trasparente. Riflettore in alluminio con chiusura in policarbonato microprismato. Terminali di chiusura in alluminio torniti. Sorgente luminosa LED multichip. Alimentatore incorporato. Rosone con collegamento elettrico e accessori di fissaggio non inclusi, da ordinare separatamente.

ES

Luminaria decorativa para instalación en suspensión, pared y techo. Cuerpo difusor de policarbonato transparente. Reflector de aluminio con terminación de policarbonato microprismático. Tapas de aluminio torneado. Fuente de iluminación LED. Balasto integrado. Roseta electricada y accesorios de fijación no incluidos, a pedir por separado.

EN

Decorative suspension, ceiling and wall lighting fitting. Transparent polycarbonate diffuser body. Aluminium reflector with microprismatic polycarbonate closure. Turned aluminium end covers. LED light source. Integrated driver. Rose ceiling for electrical connection and fixing accessories not included, to be ordered separately.

DE

Dekoratives Hänge-, Decken- und Wandbeleuchtungsgerät. Diffusor Körper aus transparentem Polycarbonat. Aluminium Reflektor mit Mikroprismenverschluss aus Polycarbonat. Endkappen aus gedrehtem Aluminium. LED-Lichtquelle. Integrierter Treiber. Deckenbefestigung für elektrische Verbindung und Befestigungszubehör nicht inbegriffen, separat zu bestellen.

FR

Appareil décoratifs en suspension, au plafond, au mur. Corp diffusant en polycarbonate transparent. Réflecteur en aluminium avec fermeture en polycarbonate microprismé. Termiaux de fermeture en aluminium décollété. Source lumineuse LED. Alimentation avec driver intégré. Patère et branchement électrique, et accessoire de fixation non inclus, à commander séparément.



LIBRA 4000 K

Code	Size	Lumen Out	Watt Tot	K	Beam angle	Driver Type	Driver	Colour
YLI11N	01	5654	43	4000	D	ON/OFF	1	○
YLI15N	02	7538	57	4000	D	ON/OFF	1	○

LIBRA 3000 K

Code	Size	Lumen Out	Watt Tot	K	Beam angle	Driver Type	Driver	Colour
YLI11W	01	5235	43	3000	D	ON/OFF	1	○
YLI15W	02	6980	57	3000	D	ON/OFF	1	○

LIBRA STANDARD COLOUR SELECTION

● **WI** | White Irazu ● **BLL** | Black Lava

LIBRA ON REQUEST COLOUR SELECTION

● **BF** | Beige Futuna ● **SB** | Silver Bombalai ● **GK** | Gold Karkar
 ● **BL** | Bronze Lario ● **RR** | Rust Rame ● **BT** | Blue Telica

LIBRA BEAM ANGLE | DIMENSIONS

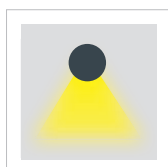

Size	X (mm)	Y (mm)	Z (mm)	Kg
01	1210	∅ 83	∅ 89	3,1
02	1590	∅ 83	∅ 89	3,8

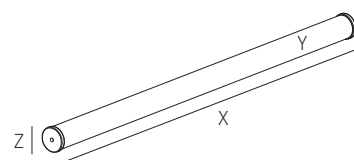

Min and Max room temperature: -20°+45° C.

LIBRA ACCESSORIES NOT INCLUDED

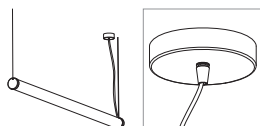

YKT10207 + ○ COLOUR

Rose ceiling for suspension installation ∅ 60 mm
 Height (30 mm)
 2 suspension cables, lenght: 2 mt

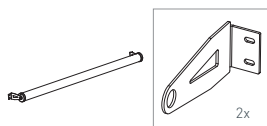

YKT10209S + ○ COLOUR

Bracket for wall/ceiling mounting system
 (2 pcs)

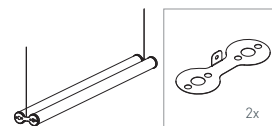

YKT10209D + ○ COLOUR

Bracket for double suspensions
 (2 pcs)
 To be ordered together with YKT10207

LIBRA SPECIAL FEATURES

Special continuous line configuration to be agreed with the technical office.





Opalia



Opalia



Decorative suspension lighting fitting

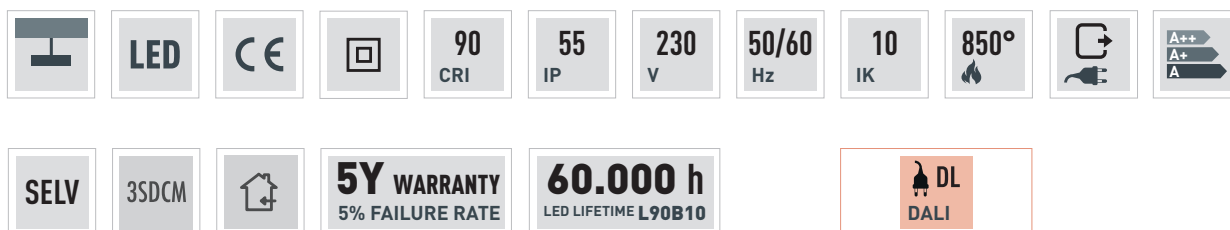

On request

IT

Apparecchio decorativo per installazione a sospensione. Corpo diffusore in policarbonato opale. Terminali di chiusura in alluminio torniti. Sorgente luminosa LED multichip. Alimentatore incorporato. Fornito completo di sospensioni in acciaio regolabili e cavo di alimentazione L=2m. Rosone per collegamento elettrico non incluso, da ordinare separatamente.

ES

Luminaria decorativa para instalación en suspensión. Cuerpo difusor de policarbonato opal. Tapas de aluminio torneado. Fuente de iluminación LED. Balasto integrado. Cables de suspensión de acero ajustables y cable de alimentación L=2m incluidos. Roseta electrificada no incluida, a pedir por separada.

EN

Decorative suspension lighting fitting. Opal polycarbonate diffuser body. Turned aluminium end covers. LED light source. Integrated driver. Supplied complete with adjustable steel suspensions and power cable L = 2m. Rose ceiling for electrical connection not included, to be ordered separately.

DE

Dekoratives Hängebeleuchtungsgerät. Diffusor Körper aus Opalpolycarbonat. Endkappen aus gedrehtem Aluminium. LED-Lichtquelle. Integrierter Treiber. Komplett mit verstellbaren Stahlhängungen und Netzkabel L = 2m. Deckenbefestigung für elektrische Verbindung nicht enthalten, separat zu bestellen.

FR

Appareil décoratifs en suspension. Corp diffusant en polycarbonate opal. Terminaux de fermeture en aluminium décollété. Source lumineuse LED. Alimentation avec driver intégré. Fourni avec fils de suspensions en acier réglables et câble d'alimentation L= 2mt. Patère et branchement électrique exclus, à commander séparément.

01



02



OPALIA 4000 K

Code	Size	Lumen Out	Watt Tot	K	Beam angle	Driver Type	Driver	Colour
YOP11N	01	6894	60	4000	D	ON/OFF	1	○
YOP15N	02	7954	69	4000	D	ON/OFF	1	○

OPALIA 3000 K

Code	Size	Lumen Out	Watt Tot	K	Beam angle	Driver Type	Driver	Colour
YOP11W	01	6383	60	3000	D	ON/OFF	1	○
YOP15W	02	7365	69	3000	D	ON/OFF	1	○

OPALIA STANDARD COLOUR SELECTION

● **WI** | White Irazu ● **BLL** | Black Lava

OPALIA ON REQUEST COLOUR SELECTION

● **BF** | Beige Futuna ● **SB** | Silver Bombalai ● **GK** | Gold Karkar
 ● **BL** | Bronze Lario ● **RR** | Rust Rame ● **BT** | Blue Telica

OPALIA BEAM ANGLE | DIMENSIONS

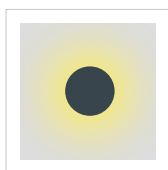

Size	X [mm]	Y [mm]	Z [mm]	Kg
01	1210	∅ 83	∅ 89	3,6
02	1590	∅ 83	∅ 89	4,5

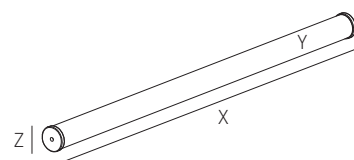

Min and Max room temperature: -20°+45° C.

OPALIA ACCESSORIES

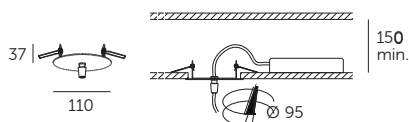

KT10301 + ○ COLOUR

Rose ceiling for installation with ceiling panel, remote driver.

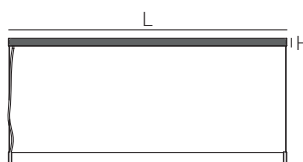

YOP11-KRO (L 1210) + ○ COLOUR

YOP15-KRO (L 1590) + ○ COLOUR

Rose ceiling for brick installation H45 mm with driver housing.

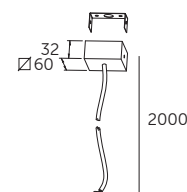

KT10501 + ○ COLOUR

Rose ceiling for brick installation without driver housing. For remote driver 24 Volt max 5 mt.





wall





SOOO UPPOD



SOO upd



Decorative wall mounted lighting fitting

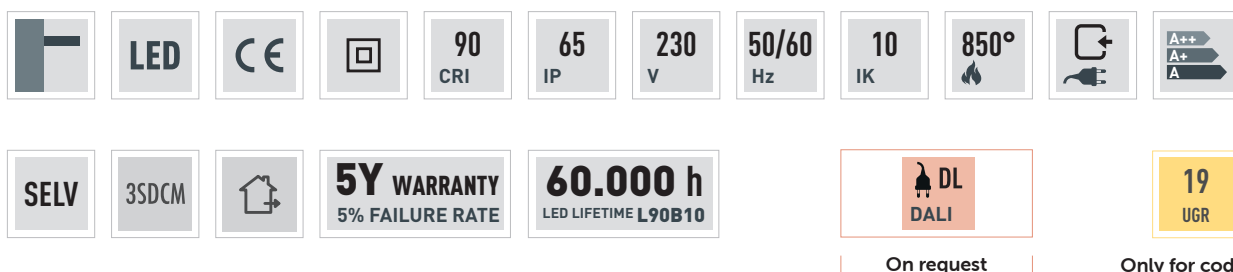

On request

Only for cod. MP

IT

Apparecchio decorativo per installazione a parete. Corpo ultrapiatto in estruso di alluminio calandrato. Sorgente luminosa LED diretta. Verniciatura con polveri epossidiche antigraffio. Diffusore in policarbonato opale (cod. OP), microprismato UGR 19 (cod. MP). Alimentatore incorporato.

EN

Decorative wall lighting fitting. Extruded linear aluminum ultra-flat body. Direct LED light source. Painted with scratch-resistant epoxy powders. Opal polycarbonate diffuser (code OP), microprismatic UGR 19 (code MP). Built-in driver.

FR

Appareil décoratifs au mur. Corps extra plat en aluminium extrudé linéaire. Source lumineuse LED indirecte. Finition de peinture en poudre époxy anti-rayures. Diffuseur en polycarbonate opal (réf. OP), microprismé UGR 19 (réf. MP). Alimentation avec driver intégré.

ES

Luminaria decorativa para instalación en pared. Cuerpo ultraplano de aluminio extruido calandrado. Fuente de iluminación LED directa. Barnizado con polvo epoxi anti-rayado. Difusor de policarbonato opal (código OP), microprismato UGR19 (código MP). Balasto integrado.

DE

Dekoratives Wandbeleuchtungsgerät. Ultraflacher Körper aus extrudiertem, kalandriertem Aluminium. Direkte LED-Lichtquelle. Lackiert mit kratzfesten Epoxidpulvern. Diffusor aus opalem Polycarbonat (Kode OP), mikroprismatisch UGR 19 (Kode MP). Integrierter elektronischer Treiber.

SOO upd



01



02

SOO upd 4000 K

Code	Diffuser	Size	Lumen Out*	Watt Tot	K	Beam angle	Driver Type	Driver Nr.	Colour
YSUP16N	OP: Opal	01	5440	64	4000	D	ON/OFF	1	○
YSUP15N		01	2720	32	4000	D	ON/OFF	1	○
YSUP21N	MP: Microprismatic	02	7140	84	4000	D	ON/OFF	1	○
YSUP20N		02	3570	42	4000	D	ON/OFF	1	○

SOO upd 3000 K

Code	Diffuser	Size	Lumen Out*	Watt Tot	K	Beam angle	Driver Type	Driver Nr.	Colour
YSUP16W	OP: Opal	01	5030	64	3000	D	ON/OFF	1	○
YSUP15W		01	2515	32	3000	D	ON/OFF	1	○
YSUP21W	MP: Microprismatic	02	6600	84	3000	D	ON/OFF	1	○
YSUP20W		02	3300	42	3000	D	ON/OFF	1	○

*Output flux with opal diffuser. With microprismatic diffuser + 10%

SOO upd STANDARD COLOUR SELECTION

● **WI** | White Irazu

● **BLL** | Black Lava

SOO upd ON REQUEST COLOUR SELECTION

● **BF** | Beige Futuna

● **SB** | Silver Bombalai

● **GK** | Gold Karkar

● **BL** | Bronze Lario

● **RR** | Rust Rame

● **BT** | Blue Telica

SOO upd BEAM ANGLE | DIMENSIONS



Size	X [mm]	Y [mm]	Z [mm]	Kg
01	1500	300	50	6
02	2000	300	50	7

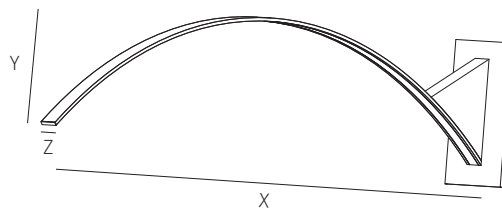

Min and Max room temperature: -20°+45° C.





SOOO m



SOO md

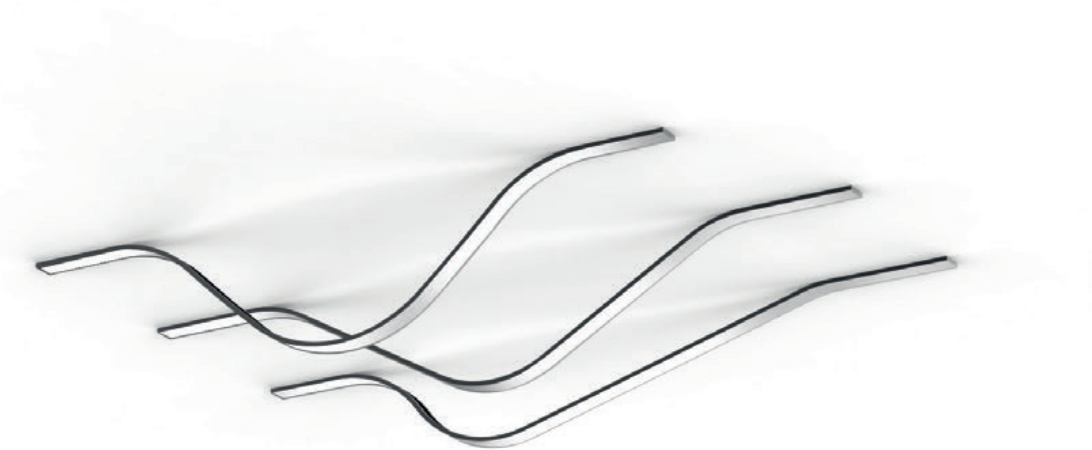

Decorative ceiling, wall mounted lighting fitting

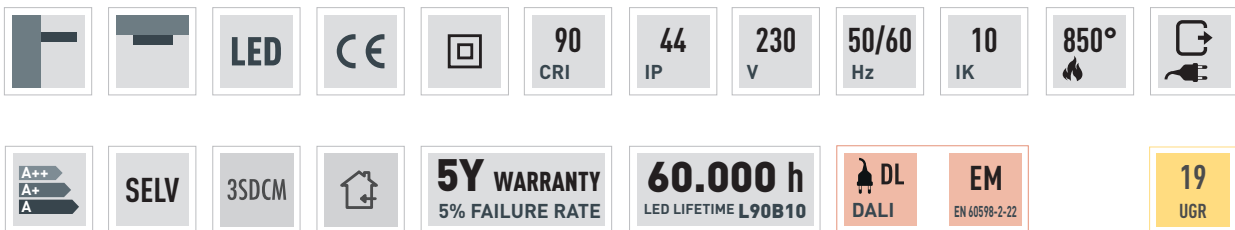

On request

Only for cod. MP

IT

Apparecchio decorativo per installazione a parete o a plafone. Corpo ultrapiatto in estruso di alluminio calandrato. Sorgente luminosa LED diretta. Verniciatura con polveri epossidiche antigraffio. Diffusore in policarbonato opale (cod. OP), microprismato UGR 19 (cod. MP). Alimentatore incluso esterno.

EN

Decorative wall or ceiling lighting fitting. Extruded linear aluminum ultra-flat body. Direct LED light source. Painted with scratch-resistant epoxy powders. Opal polycarbonate diffuser (code OP), microprismatic UGR 19 (code MP). External driver included.

FR

Appareil décoratifs au mur et au lafond. Corps extra plat en aluminium extrudé linéaire. Source lumineuse LED directe. Finition de peinture en poudre époxy anti-rayures. Diffuseur en polycarbonate opal (réf. OP), microprismé UGR 19 (réf. MP). Driver externe inclus.

ES

Luminaria decorativa para instalación en pared y techo. Cuerpo ultraplano de aluminio extruido calandrado. Fuente de iluminación LED directa. Barnizado con polvo epoxi anti-rayado. Difusor de policarbonato opal (código OP), microprismato UGR19 (código MP). Balasto externo incluido.

DE

Dekoratives Wand- und Deckenbeleuchtungsgerät. Ultraflacher Körper aus extrudiertem, kalandriertem Aluminium. Direkte LED-Lichtquelle. Lackiert mit kratzfesten Epoxidpulvern. Diffusor aus opalem Polycarbonat (Kode OP), mikroprismatisch UGR 19 (Kode MP). Externer elektronischer Treiber enthalten.

SOO md

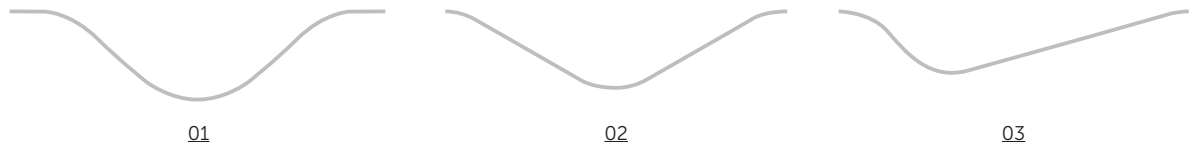

SOO md 4000 K

Code	Diffuser	Size	Lumen Out*	Watt Tot	K	Beam angle	Driver Type	Driver Nr.	Colour
YSMD19N		01	6800	80	4000	D	ON/OFF	1	○
YSMD18N	OP: Opal	01	3400	40	4000	D	ON/OFF	1	○
YSMD21N		02	6800	80	4000	D	ON/OFF	1	○
YSMD20N	MP: Microprismatic	02	3400	40	4000	D	ON/OFF	1	○
YSMD31N		03	6800	80	4000	D	ON/OFF	1	○
YSMD30N		03	3400	40	4000	D	ON/OFF	1	○

SOO md 3000 K

Code	Diffuser	Size	Lumen Out*	Watt Tot	K	Beam angle	Driver Type	Driver Nr.	Colour
YSMD19W		01	6240	80	3000	D	ON/OFF	1	○
YSMD18W	OP: Opal	01	3120	40	3000	D	ON/OFF	1	○
YSMD21W		02	6240	80	3000	D	ON/OFF	1	○
YSMD20W	MP: Microprismatic	02	3120	40	3000	D	ON/OFF	1	○
YSMD31W		03	6240	80	3000	D	ON/OFF	1	○
YSMD30W		03	3120	40	3000	D	ON/OFF	1	○

*Output flux with opal diffuser. With microprismatic diffuser + 10%

SOO md STANDARD COLOUR SELECTION

● **WI** | White Irazu ● **BLL** | Black Lava

SOO md ON REQUEST COLOUR SELECTION

● **BF** | Beige Futuna ● **SB** | Silver Bombalai ● **GK** | Gold Karkar
 ● **BL** | Bronze Lario ● **RR** | Rust Rame ● **BT** | Blue Telica

SOO md BEAM ANGLE | DIMENSIONS



Size	X (mm)	Y (mm)	Z (mm)	Kg
01	1800	300	50	2
02	1800	250	50	2
03	1800	250	50	2

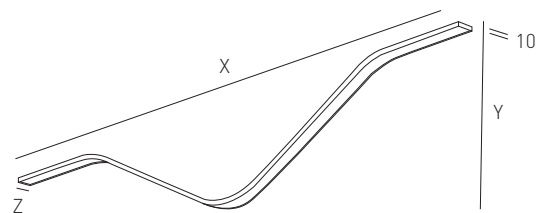

Min and Max room temperature: -20°+45° C.

SOO mi



Decorative ceiling, wall mounted lighting fitting

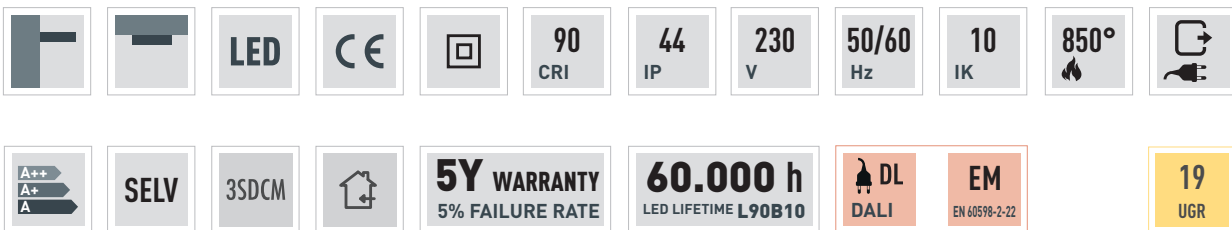

On request

IT

Apparecchio decorativo per installazione a parete o a plafone. Corpo ultrapiatto in estruso di alluminio calandrato. Sorgente luminosa LED indiretta. Verniciatura con polveri epossidiche antigraffio. Diffusore in policarbonato opale (cod. OP), microprismato UGR 19 (cod. MP). Alimentatore incluso esterno.

ES

Luminaria decorativa para instalación en pared y techo. Cuerpo ultraplano de aluminio extruido calandrado. Fuente de iluminación LED indirecta. Barnizado con polvo epoxi anti-rayado. Difusor de policarbonato opal (código OP), microprismato UGR19 (código MP). Balasto externo incluido.

EN

Decorative wall or ceiling lighting fitting. Extruded linear aluminum ultra-flat body. Indirect LED light source. Painted with scratch-resistant epoxy powders. Opal polycarbonate diffuser (code OP), microprismatic UGR 19 (code MP). External driver included.

DE

Dekoratives Wand- und Deckenbeleuchtungsgerät. Ultraflacher Körper aus extrudiertem, kalandriertem Aluminium. Indirekte LED-Lichtquelle. Lackiert mit kratzfesten Epoxidpulvern. Diffusor aus opalem Polycarbonat (Kode OP), mikroprismatisch UGR 19 (Kode MP). Externer elektronischer Treiber enthalten.

FR

Appareil décoratifs au mur et au plafond. Corps extra plat en aluminium extrudé linéaire. Source lumineuse LED indirecte. Finition de peinture en poudre époxy anti-rayures. Diffuseur en polycarbonate opal (réf. OP), microprismé UGR 19 (réf. MP). Driver externe inclus.

SOO mi

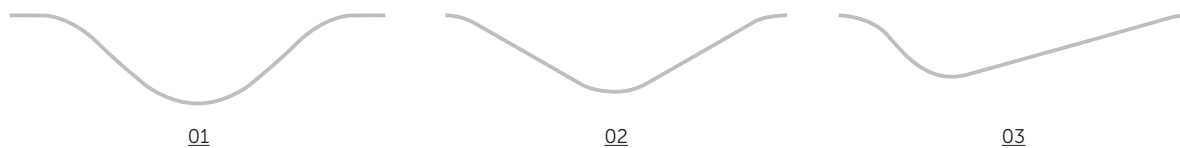

SOO mi 4000 K

Code	Diffuser	Size	Lumen Out*	Watt Tot	K	Beam angle	Driver Type	Driver Nr.	Colour
YSMI19N		01	4420	52	4000	D	ON/OFF	1	○
YSMI18N	OP:	01	2210	27	4000	D	ON/OFF	1	○
YSMI21N	Opal	02	4420	52	4000	D	ON/OFF	1	○
YSMI20N	MP:	02	2210	27	4000	D	ON/OFF	1	○
YSMI31N	Microprismatic	03	4420	52	4000	D	ON/OFF	1	○
YSMI30N		03	2210	27	4000	D	ON/OFF	1	○

SOO mi 3000 K

Code	Diffuser	Size	Lumen Out*	Watt Tot	K	Beam angle	Driver Type	Driver Nr.	Colour
YSMI19W		01	4070	52	3000	D	ON/OFF	1	○
YSMI18W	OP:	01	2035	27	3000	D	ON/OFF	1	○
YSMI21W	Opal	02	4070	52	3000	D	ON/OFF	1	○
YSMI20W	MP:	02	2035	27	3000	D	ON/OFF	1	○
YSMI31W	Microprismatic	03	4070	52	3000	D	ON/OFF	1	○
YSMI30W		03	2210	27	3000	D	ON/OFF	1	○

*Output flux with opal diffuser. With microprismatic diffuser + 10%

SOO mi STANDARD COLOUR SELECTION

● **WI** | White Irazu ● **BLL** | Black Lava

SOO mi ON REQUEST COLOUR SELECTION

● **BF** | Beige Futuna ● **SB** | Silver Bombalai ● **GK** | Gold Karkar
 ● **BL** | Bronze Lario ● **RR** | Rust Rame ● **BT** | Blue Telica

SOO mi BEAM ANGLE | DIMENSIONS

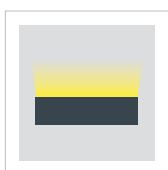

Size	X (mm)	Y (mm)	Z (mm)	Kg
01	1800	360	50	2
02	1800	250	50	2
03	1800	250	50	2

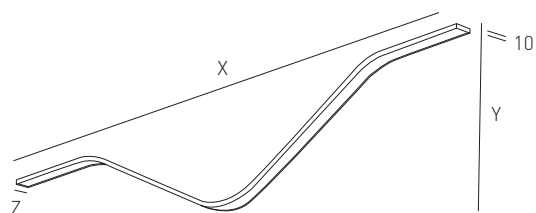

Min and Max room temperature: -20°+45° C.





S O O O p



SOO pi

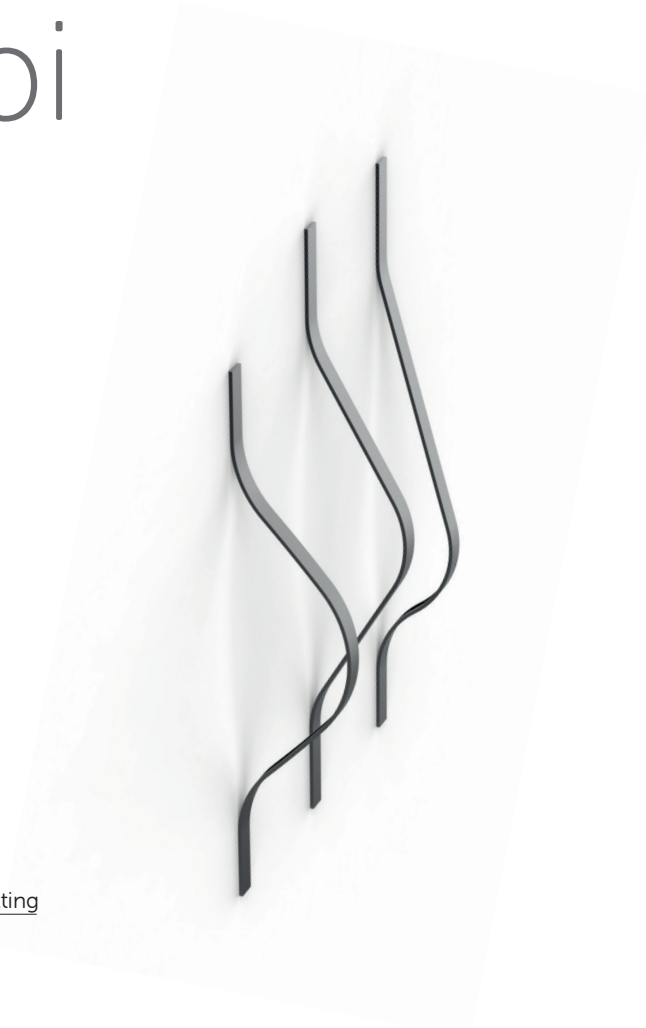

Decorative wall mounted lighting fitting

	LED			90 CRI	44 IP	230 V	50/60 Hz	10 IK	850° 		
SELV	3SDCM		5Y WARRANTY 5% FAILURE RATE	60.000 h LED LIFETIME L90B10		EM EN 60598-2-22	19 UGR				

On request

IT

Apparecchio decorativo per installazione a parete. Corpo ultrapiatto in estruso di alluminio calandrato. Sorgente luminosa LED indiretta. Verniciatura con polveri epossidiche antigraffio. Diffusore in policarbonato opale (cod. OP), microprismatico UGR 19 (cod. MP). Alimentatore incluso esterno.

EN

Decorative wall lighting fitting. Extruded linear aluminum ultra-flat body. Indirect LED light source. Painted with scratch-resistant epoxy powders. Opal polycarbonate diffuser (code OP), microprismatic UGR 19 (code MP). External driver included.

FR

Appareil décoratifs au mur. Corps extra plat en aluminium extrudé linéaire. Source lumineuse LED indirecte. Finition de peinture en poudre époxy anti-rayures. Diffuseur en polycarbonate opal (réf. OP), microprismé UGR 19 (réf. MP). Driver externe inclus.

ES

Luminaria decorativa para instalación en pared. Cuerpo ultraplano de aluminio extruido calandrado. Fuente de iluminación LED indirecta. Barnizado con polvo epoxi anti-rayado. Difusor de policarbonato opal (código OP), microprismatico UGR19 (código MP). Balasto externo incluido.

DE

Dekoratives Wandbeleuchtungsgerät. Ultraflacher Körper aus extrudiertem, kalandriertem Aluminium. Indirekte LED-Lichtquelle. Lackiert mit kratzfesten Epoxidpulvern. Diffusor aus opalem Polycarbonat (Kode OP), mikroprismatisch UGR 19 (Kode MP). Externer elektronischer Treiber enthalten.

SOO pi

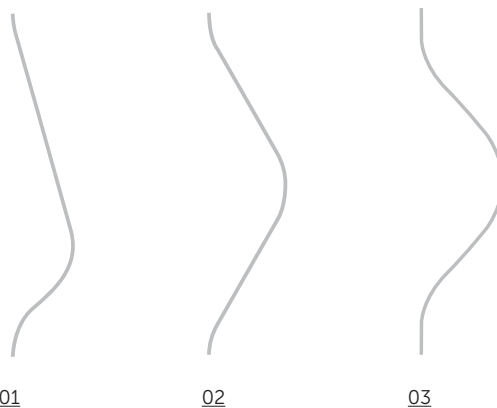

SOO pi 4000 K

Code	Diffuser	Size	Lumen Out*	Watt Tot	K	Beam angle	Driver Type	Driver Nr.	Colour
YSPI26N		01	7480	88	4000	D	ON/OFF	1	○
YSPI25N	OP: Opal	01	3740	44	4000	D	ON/OFF	1	○
YSPI31N		02	7480	88	4000	D	ON/OFF	1	○
YSPI30N	MP: Microprismatic	02	3740	44	4000	D	ON/OFF	1	○
YSPI41N		03	7480	88	4000	D	ON/OFF	1	○
YSPI40N		03	3740	44	4000	D	ON/OFF	1	○

SOO pi 3000 K

Code	Diffuser	Size	Lumen Out*	Watt Tot	K	Beam angle	Driver Type	Driver Nr.	Colour
YSPI26W		01	6880	88	3000	D	ON/OFF	1	○
YSPI25W	OP: Opal	01	3440	44	3000	D	ON/OFF	1	○
YSPI31W		02	6880	88	3000	D	ON/OFF	1	○
YSPI30W	MP: Microprismatic	02	3440	44	3000	D	ON/OFF	1	○
YSPI41W		03	6880	88	3000	D	ON/OFF	1	○
YSPI40W		03	3440	44	3000	D	ON/OFF	1	○

*Output flux with opal diffuser. With microprismatic diffuser + 10%

SOO pi STANDARD COLOUR SELECTION

● **WI** | White Irazu ● **BLL** | Black Lava

SOO pi ON REQUEST COLOUR SELECTION

● **BF** | Beige Futuna ● **SB** | Silver Bombalai ● **GK** | Gold Karkar
 ● **BL** | Bronze Lario ● **RR** | Rust Rame ● **BT** | Blue Telica

SOO pi BEAM ANGLE | DIMENSIONS



Size	X [mm]	Y [mm]	Z [mm]	Kg
01	2500	300	50	
02	2500	300	50	
03	2500	400	50	

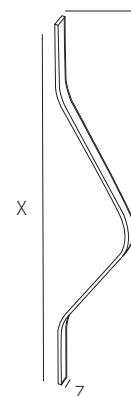

Min and Max room temperature: -20°+45° C.





SOOO Wi



SOO wi

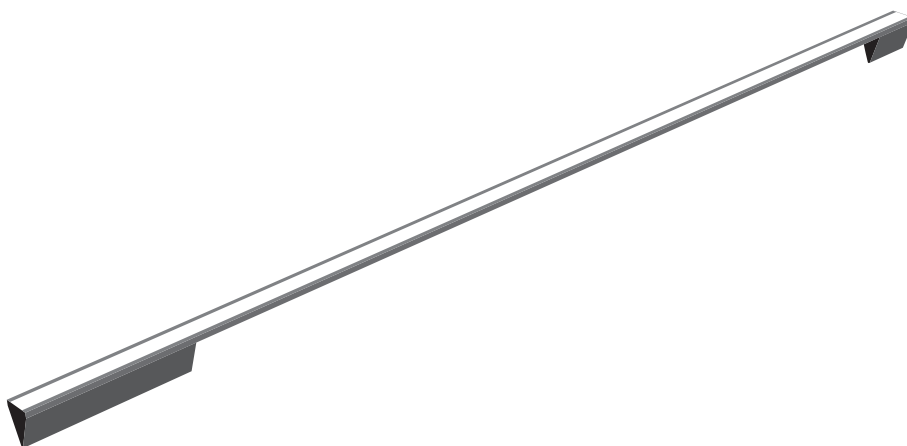

Decorative wall mounted lighting fitting

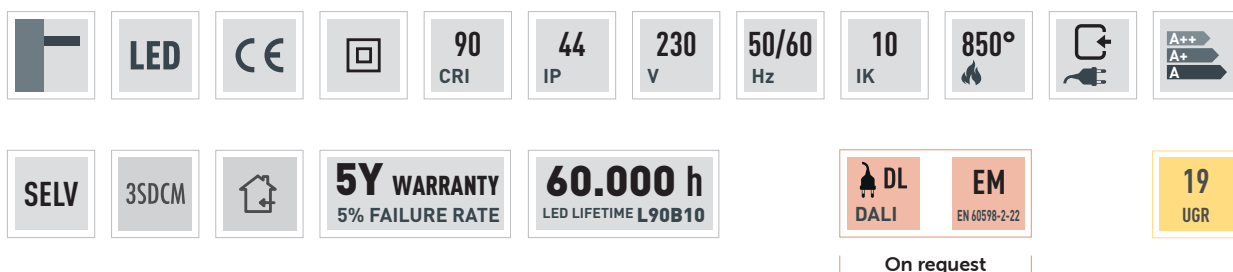

On request

IT

Apparecchio decorativo per installazione a parete. Corpo ultrapiatto in estruso di alluminio calandrato. Sorgente luminosa LED indiretta. Verniciatura con polveri epossidiche antigraffio. Diffusore in policarbonato opale (cod. OP), microprismato UGR 19 (cod. MP). Alimentatore incluso esterno.

EN

Decorative wall lighting fitting. Extruded linear aluminum ultra-flat body. Indirect LED light source. Painted with scratch-resistant epoxy powders. Opal polycarbonate diffuser (code OP), microprismatic UGR 19 (code MP). External driver included.

FR

Appareil décoratifs au mur. Corps extra plat en aluminium extrudé linéaire. Source lumineuse LED indirecte. Finition de peinture en poudre époxy anti-rayures. Diffuseur en polycarbonate opal (réf. OP), microprismé UGR 19 (réf. MP). Driver externe inclus.

ES

Luminaria decorativa para instalación en pared. Cuerpo ultraplano de aluminio extruido calandrado. Fuente de iluminación LED indirecta. Barnizado con polvo epoxi anti-rayado. Difusor de policarbonato opal (código OP), microprismato UGR19 (código MP). Balasto externo incluido.

DE

Dekoratives Wandbeleuchtungsgerät. Ultraflacher Körper aus extrudiertem, kalandriertem Aluminium. Indirekte LED-Lichtquelle. Lackiert mit kratzfesten Epoxidpulvern. Diffusor aus opalem Polycarbonat (Kode OP), mikroprismatisch UGR 19 (Kode MP). Externer elektronischer Treiber enthalten.



SOO wi 4000 K

Code	Diffuser	Size	Lumen Out*	Watt Tot	K	Beam angle	Driver Type	Driver Nr.	Colour
YSWI16N		01	5480	64	4000	D	ON/OFF	1	○
YSWI15N	OP: Opal	01	2740	32	4000	D	ON/OFF	1	○
YSWI21N		02	7140	84	4000	D	ON/OFF	1	○
YSWI20N	MP: Microprismatic	02	3570	42	4000	D	ON/OFF	1	○
YSWI26N		03	8670	102	4000	D	ON/OFF	1	○
YSWI25N		03	4335	51	4000	D	ON/OFF	1	○

SOO wi 3000 K

Code	Diffuser	Size	Lumen Out*	Watt Tot	K	Beam angle	Driver Type	Driver Nr.	Colour
YSWI16N		01	5040	64	3000	D	ON/OFF	1	○
YSWI15N	OP: Opal	01	2520	32	3000	D	ON/OFF	1	○
YSWI21N		02	6570	84	3000	D	ON/OFF	1	○
YSWI20N	MP: Microprismatic	02	3280	42	3000	D	ON/OFF	1	○
YSWI26N		03	7980	102	3000	D	ON/OFF	1	○
YSWI25N		03	3990	51	3000	D	ON/OFF	1	○

*Output flux with opal diffuser. With microprismatic diffuser + 10%

SOO wi STANDARD COLOUR SELECTION

● **WI** | White Irazu ● **BLL** | Black Lava

SOO wi ON REQUEST COLOUR SELECTION

● **BF** | Beige Futuna ● **SB** | Silver Bombalai ● **GK** | Gold Karkar
 ● **BL** | Bronze Lario ● **RR** | Rust Rame ● **BT** | Blue Telica

SOO wi BEAM ANGLE | DIMENSIONS



Size	X [mm]	Y [mm]	Z [mm]	Kg
01	1500	50	50	2,4
02	2000	50	50	2,8
03	2500	50	50	3,2

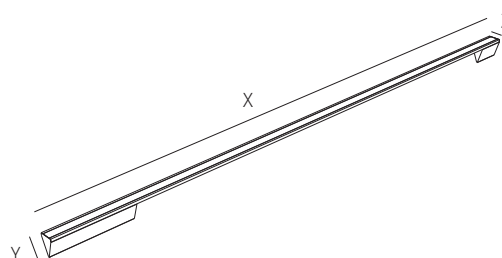

Min and Max room temperature: -20°+45° C.





Alboa



Alba



Decorative wall mounted lighting fitting

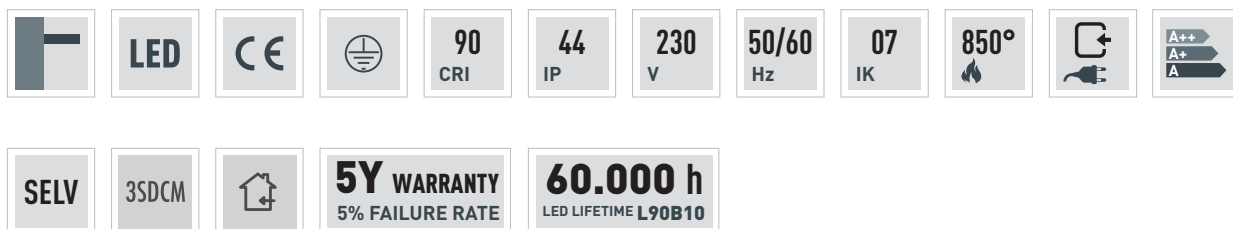

IT

Apparecchio decorativo per installazione a parete. Corpo in estruso di alluminio calandrato. Sorgente luminosa LED indiretta. Verniciatura con polveri epossidiche antigraffio. Schermo di chiusura in silicone opale. Alimentatore incorporato.

ES

Luminaria decorativa para instalación en pared. Cuerpo de aluminio extruido y calandrado. Fuente de iluminación LED indirecta. Barnizado con polvo epoxi anti-rayado. Difusor de silicona opal. Balasto integrado.

EN

Decorative wall lighting fitting. Extruded and calendered aluminium body. Indirect LED light source. Painted with scratch-resistant epoxy powders. Opal silicone closing reflector. Built-in driver.

DE

Dekoratives Wandbeleuchtungsgerät. Extrudierter und kalandrierter Aluminiumkörper. Indirekte LED-Lichtquelle. Lackiert mit kratzfesten Epoxidpulvern. Opalabdeckschirm aus Silikon. Integrierter Treiber.

FR

Appareil décoratifs au mur. Corps en aluminium extrudé et calandré. Source lumineuse LED indirecte. Finition de peinture en poudre époxy anti-rayures. Écran de fermeture en silicone opale. Alimentation avec driver intégré.



ALBA 4000 K

Code	Size	Lumen Out	Watt Tot	K	Beam angle	Driver Type	Driver no.	Colour
YAL16N	01	1461	10	4000	D	ON/OFF	1	○

ALBA 3000 K

Code	Size	Lumen Out	Watt Tot	K	Beam angle	Driver Type	Driver no.	Colour
YAL16W	01	1353	10	3000	D	ON/OFF	1	○

ALBA STANDARD COLOUR SELECTION

● **WI** | White Irazu ● **BLL** | Black Lava

ALBA ON REQUEST COLOUR SELECTION

● **BF** | Beige Futuna ● **SB** | Silver Bombalai ● **GK** | Gold Karkar
 ● **BL** | Bronze Lario ● **RR** | Rust Rame ● **BT** | Blue Telica

ALBA BEAM ANGLE | DIMENSIONS

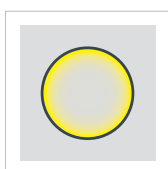

Size	X [mm]	Y [mm]	Z [mm]	Kg
A	∅ 165	12	250	0,6

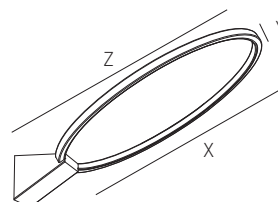

Min and Max room temperature: -20°+45° C.





Tink



Tink

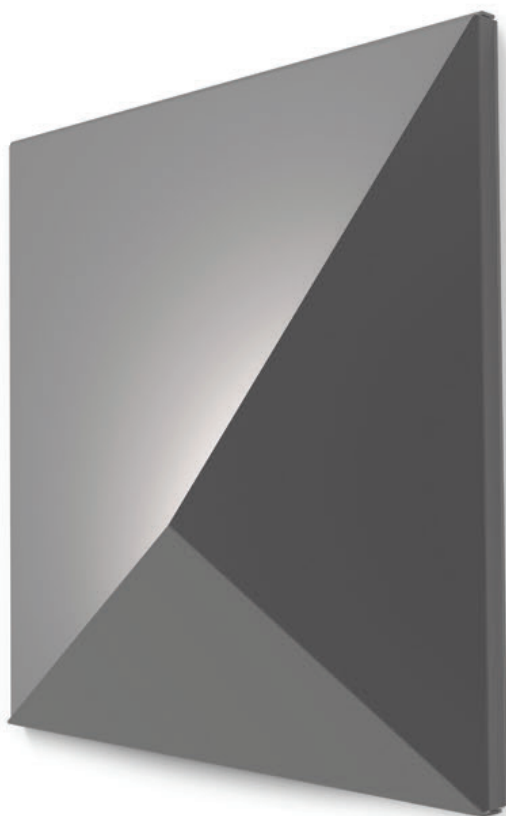

Decorative wall mounted lighting fitting

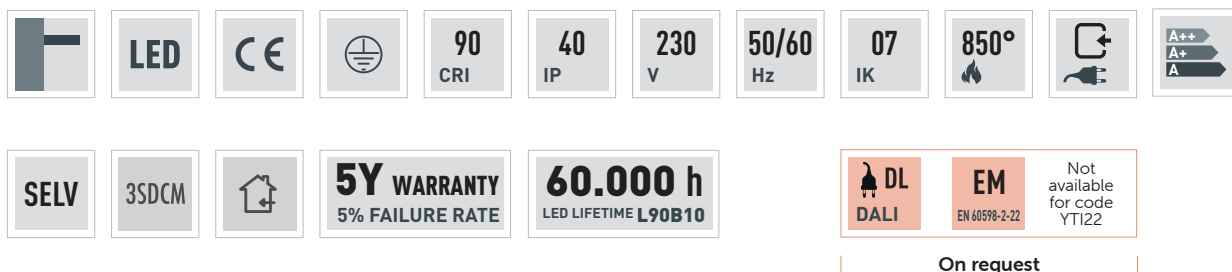

On request

IT

Apparecchio decorativo per installazione a parete. Corpo in acciaio al carbonio pressopiegato. Sorgente luminosa LED multichip. Verniciatura con polveri epossidiche antigraffio. Schermo di chiusura in policarbonato opalino. Alimentatore incorporato.

ES

Luminaria decorativa para instalación en pared. Cuerpo de acero al carbono plegado. Fuente de iluminación LED. Barnizado con polvo epoxi anti-rayado. Difusor de policarbonato opal. Balasto integrado.

EN

Decorative wall lighting fitting. Bent carbon steel body. Multichip LED light source. Painted with scratch-resistant epoxy powders. Opal polycarbonate closing reflector. Built-in driver.

DE

Dekoratives Wandbeleuchtungsgerät. Körper aus pressgeformtem Kohlenstoffstahl. LED-Lichtquelle. Lackiert mit kratzfesten Epoxidpulvern. Abdeckschirm aus opalem Polycarbonat. Integrierter Treiber.

FR

Appareil décoratifs au mur. Corps en acier au carbone plies à la presse. Source lumineuse LED. Finition de peinture en poudre époxy anti-rayures. Écran de fermeture en polycarbonate opale. Alimentation avec driver intégré.

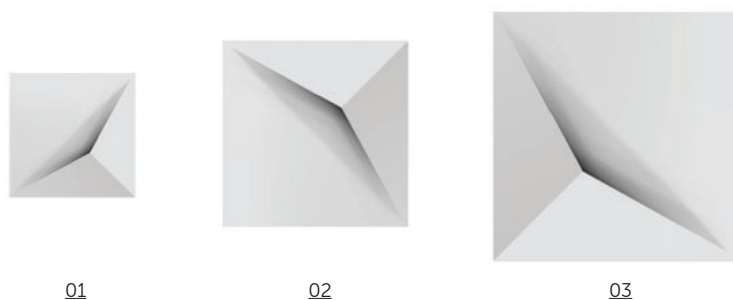

TINK 4000 K

Code	Size	Lumen Out	Watt Tot	K	Beam angle	Driver Type	Driver no.	Colour
YTI22N	01	3013	30	4000	D	ON/OFF	1	○
YTI30N	02	6313	65	4000	D	ON/OFF	2	○
YTI50N	03	11354	111	4000	D	ON/OFF	4	○

TINK 3000

Code	Size	Lumen Out	Watt Tot	K	Beam angle	Driver Type	Driver no.	Colour
YTI22W	01	2790	30	3000	D	ON/OFF	1	○
YTI30W	02	5845	65	3000	D	ON/OFF	2	○
YTI50W	03	10513	111	3000	D	ON/OFF	4	○

TINK STANDARD COLOUR SELECTION

● **WI** | White Irazu ● **BLL** | Black Lava

TINK ON REQUEST COLOUR SELECTION

● **BF** | Beige Futuna ● **SB** | Silver Bombalai ● **GK** | Gold Karkar
 ● **BL** | Bronze Lario ● **RR** | Rust Rame ● **BT** | Blue Telica

TINK BEAM ANGLE | DIMENSIONS



Size	X [mm]	Y [mm]	Z [mm]	Kg
01	220	220	70	1,6
02	300	300	85	2,2
03	500	500	130	3,7

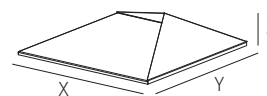

Min and Max room temperature: -20°+45° C.

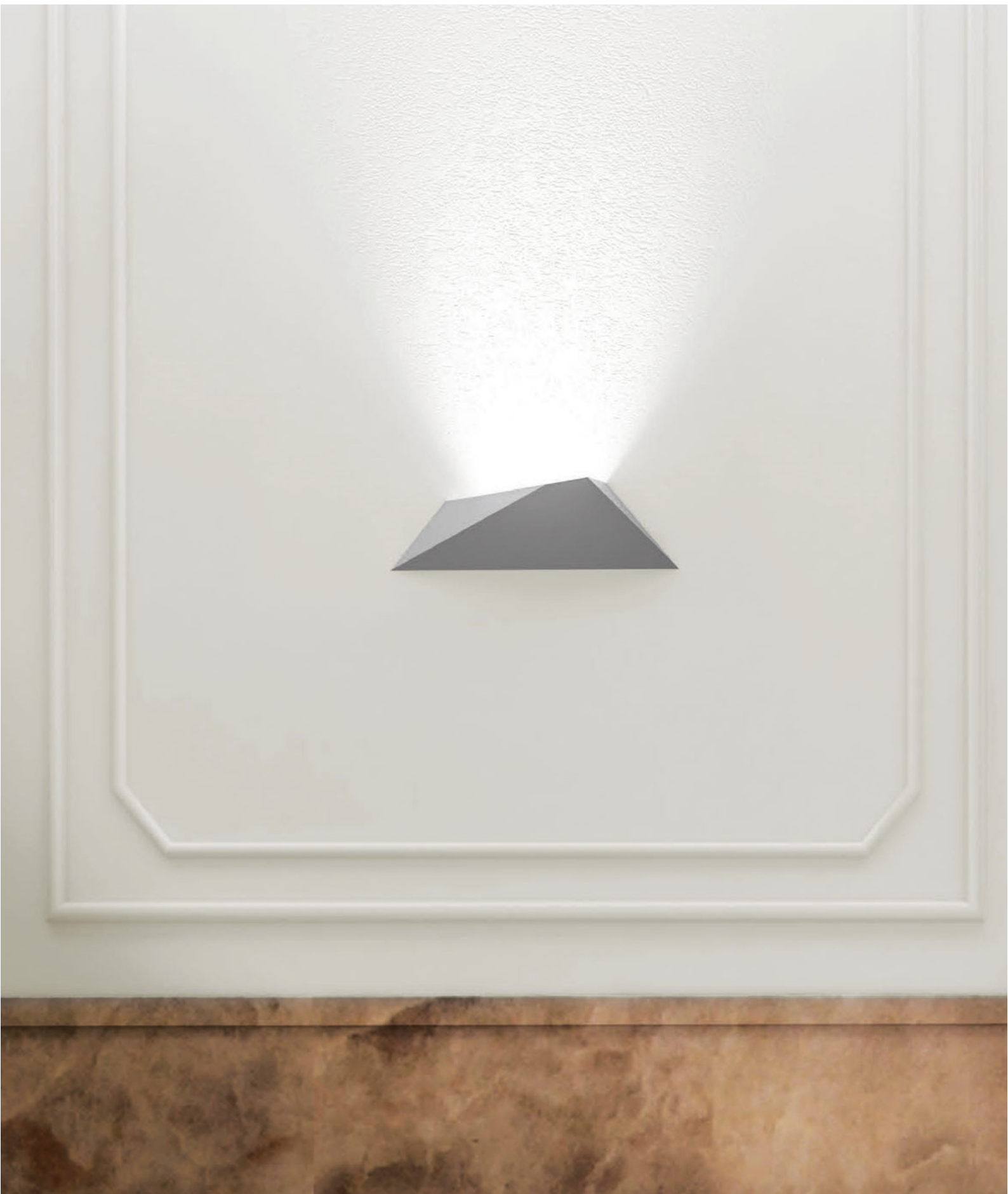



Faces m



Faces m

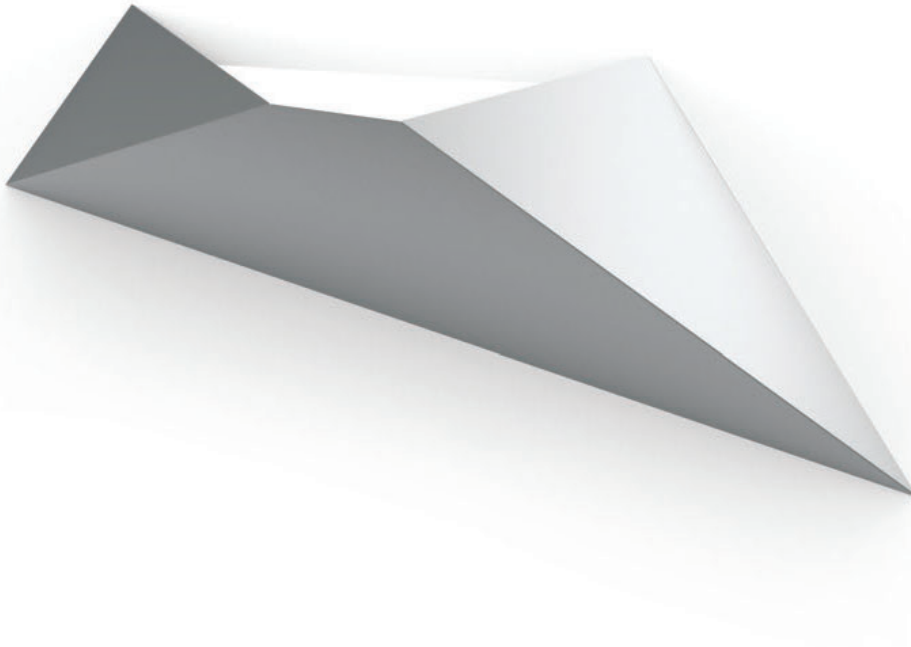

Decorative wall mounted lighting fitting

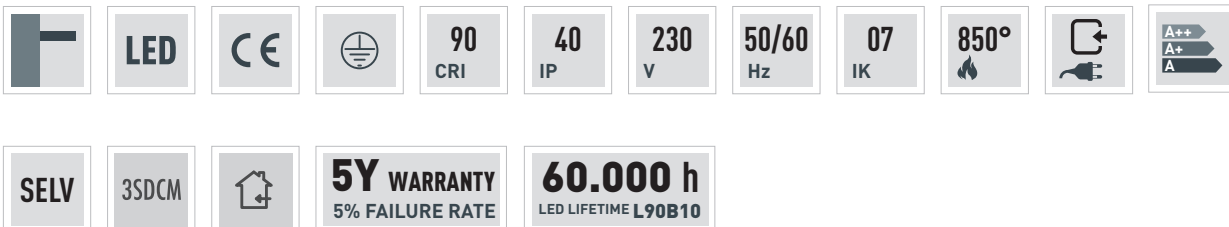

IT

Apparecchio decorativo per installazione a parete. Corpo in acciaio al carbonio pressopiegato. Frontale intercambiabile con fissaggio magnetico da ordinare unitamente alla base specificando il colore. Sorgente luminosa LED multichip. Verniciatura con polveri epossidiche antigraffio. Schermo di chiusura in policarbonato opalino. Alimentatore incorporato.

ES

Luminaria decorativa para instalación en pared. Cuerpo de acero al carbono plegado. Panel frontal intercambiable con fijación magnética a pedir junto con la base especificando el color. Fuente de iluminación LED. Barnizado con polvo epoxi anti-rayado. Difusor de policarbonato opal. Balasto integrado.

EN

Decorative wall lighting fitting. Bent carbon steel body. Interchangeable front with magnetic fixing, to be ordered separately together with the base, indicating the colour. Multichip LED light source. Painted with scratch-resistant epoxy powders. Opal polycarbonate closing reflector. Built-in driver.

DE

Dekoratives Wandbeleuchtungsgerät. Körper aus pressgeformtem Kohlenstoffstahl. Auswechselbare Vorderer mit magnetischer Befestigung, zusammen mit Verdrahtungsbasis LED-Lichtquelle. Lackiert mit kratzfesten Epoxidpulvern. Abdeckschirm aus opalem Polycarbonat. Integrierter Treiber.

FR

Appareil décoratifs au mur. Corps en acier au carbone plies à la presse. Partie frontale avec fixation aimantée à commander avec la base en précisant la couleur. Source lumineuse LED. Finition de peinture en poudre époxy anti-rayures Écran de fermeture en polycarbonate opale. Alimentation avec driver intégré.

Faces m

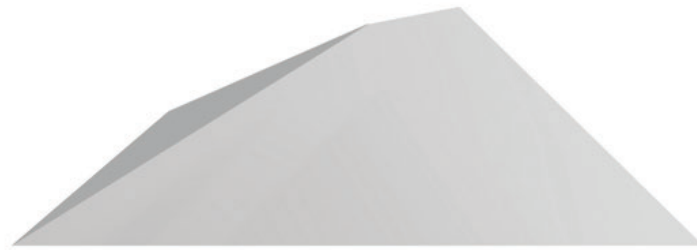

FACES M BASE 4000 K

Code	Size	Lumen Out	Watt Tot	K	Beam angle	Driver Type	Driver no.
YFAM14N	01	2400	28	4000	D	ON/OFF	1

FACES M BASE 3000 K

Code	Size	Lumen Out	Watt Tot	K	Beam angle	Driver Type	Driver no.
YFAM14W	01	2223	28	3000	D	ON/OFF	1

FACES M MAGNETIC COVER

Code	Size	Colours
YFAFM145	01	○

FACES M STANDARD COLOUR SELECTION

● **WI** | White Irazu ● **BLL** | Black Lava

FACES M ON REQUEST COLOUR SELECTION

● **BF** | Beige Futuna ● **SB** | Silver Bombalai ● **GK** | Gold Karkar
 ● **BL** | Bronze Lario ● **RR** | Rust Rame ● **BT** | Blue Telica

FACES M BEAM ANGLE | DIMENSIONS



Size	X (mm)	Y (mm)	Z (mm)	Kg
A	145	600	115	1,8

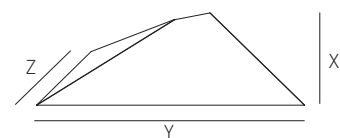

Min and Max room temperature: -20°+45° C.





Calea



Calea



Decorative wall mounted lighting fitting

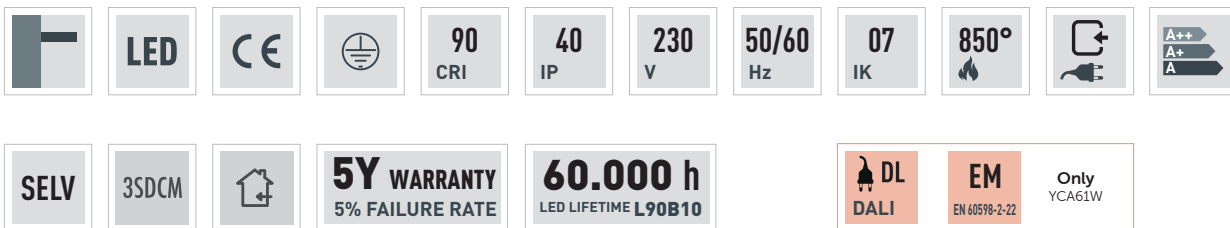

On request

IT

Apparecchio decorativo per installazione a parete. Corpo in acciaio al carbonio pressopiegato. Sorgente luminosa LED multichip. Verniciatura con polveri epossidiche antigraffio. Schermo di chiusura in policarbonato microprismato. Alimentatore incorporato.

ES

Luminaria decorativa para instalación en pared. Cuerpo de acero al carbono plegado. Fuente de iluminación LED. Barnizado con polvo epoxi anti-rayado. Difusor de policarbonato microprismático. Balasto integrado.

EN

Decorative wall lighting fitting. Bent carbon steel body. Multichip LED light source. Painted with scratch-resistant epoxy powders. Microprismatic polycarbonate closing reflector. Built-in driver.

DE

Dekoratives Wandbeleuchtungsgerät. Körper aus pressgeformtem Kohlenstoffstahl. LED-Lichtquelle. Lackiert mit kratzfesten Epoxidpulvern. Abdeckschirm aus mikrop Prismatischem Polycarbonat. Integrierter Treiber.

FR

Appareil décoratifs au mur. Corps en acier au carbone plies à la presse. Source lumineuse LED. Finition de peinture en poudre époxy anti-rayures. Écran de fermeture en polycarbonate microprismatique. Alimentation avec driver intégré.



01



02



03

CALEA 4000 K

Code	Size	Lumen Out	Watt Tot	K	Beam angle	Driver Type	Driver no.	Colour
YCA21N	01	3410	42	4000	D	ON/OFF	1	○
YCA41N	02	6810	84	4000	D	ON/OFF	2	○
YCA61N	03	10290	127	4000	D	ON/OFF	3	○

CALEA 3000 K

Code	Size	Lumen Out	Watt Tot	K	Beam angle	Driver Type	Driver no.	Colour
YCA21W	01	3150	42	3000	D	ON/OFF	1	○
YCA41W	02	6300	84	3000	D	ON/OFF	2	○
YCA61W	03	9525	127	3000	D	ON/OFF	3	○

CALEA STANDARD COLOUR SELECTION

● **WI** | White Irazu ● **BLL** | Black Lava

CALEA ON REQUEST COLOUR SELECTION

● **BF** | Beige Futuna ● **SB** | Silver Bombalai ● **GK** | Gold Karkar
 ● **BL** | Bronze Lario ● **RR** | Rust Rame ● **BT** | Blue Telica

CALEA BEAM ANGLE | DIMENSIONS



Size	X [mm]	Y [mm]	Z [mm]	J [mm]	K [mm]	Kg
01	210	183	183	26	26	2,7
02	410	183	183	26	26	5,4
03	610	183	183	26	26	8,2

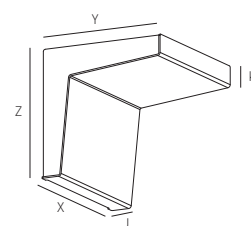

Min and Max room temperature: -20°+45° C.





Zoe



Zoe m



Decorative wall mounted lighting fitting

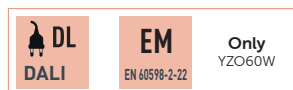

On request

IT

Apparecchio decorativo per installazione a parete. Base portacablaggio con sorgente luminosa LED multichip e schermo di chiusura in policarbonato opalino. Frontale in acciaio al carbonio pressopiegato intercambiabile con fissaggio magnetico. Verniciatura con polveri epossidiche antigraffio. Alimentatore incorporato.

EN

Appareil décoratifs au mur. Socle de câblage avec source lumineuse LED et écran de fermeture en polycarbonate opale. Avant en acier au carbon interchangeable avec fixation magnetique. Finition de peinture en poudre époxy anti-rayures. Alimentation avec driver intégré.

FR

Appareil décoratifs au mur. Socle de câblage avec source lumineuse LED et écran de fermeture en polycarbonate opale. Avant en acier au carbon interchangeable avec fixation magnetique. Finition de peinture en poudre époxy anti-rayures. Alimentation avec driver intégré.

ES

Luminaria decorativa para instalación en pared. Base soporte de cableado con fuente de iluminación LED multichip y difusor de policarbonato opal. Panel frontal de carbono plegado a presión intercambiable con sistema de fijación magnético. Barnizado con polvo epoxi anti-rayado. Balasto integrado.

DE

Dekoratives Wandbeleuchtungsgerät. Verdrahtungsbasis mit multichip LED Leuchtmittel und Abdeckschirm aus opalem Polycarbonat. Auswechselbare Vordere aus pressgeformtem Kohlenstoffstahl mit magnetischer Befestigung. Lackiert mit kratzfesten Epoxidpulvern. Integrierter Treiber.



01

02

03

ZOE M BASE 4000 K

Code	Size	Lumen Out	Watt Tot	K	Beam angle	Driver Type	Driver no.
DIRECT + INDIRECT EMISSION (D+I)							
YZOM23N	01	1735	22	4000	D	ON/OFF	1
YZOM40N	02	3315	42	4000	D	ON/OFF	1
YZOM60N	03	5125	65	4000	D	ON/OFF	1

ZOE M BASE 3000 K

Code	Size	Lumen Out	Watt Tot	K	Beam angle	Driver Type	Driver no.
DIRECT + INDIRECT EMISSION (D+I)							
YZOM23W	01	1610	22	3000	D	ON/OFF	1
YZOM40W	02	3070	42	3000	D	ON/OFF	1
YZOM60W	03	4745	65	3000	D	ON/OFF	1

ZOE M MAGNETIC COVER

Code	Size	Colour
YZOFM225	01	○
YZOFM395	02	○
YZOFM595	03	○

ZOE M STANDARD COLOUR SELECTION

● **WI** | White Irazu ● **BLL** | Black Lava

ZOE M ON REQUEST COLOUR SELECTION

● **BF** | Beige Futuna ● **SB** | Silver Bombalai ● **GK** | Gold Karkar
 ● **BL** | Bronze Lario ● **RR** | Rust Rame ● **BT** | Blue Telica

ZOE M BEAM ANGLE | DIMENSIONS

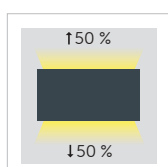

Size	X (mm)	Y (mm)	Z (mm)	Kg
01	70	225	115	1,1
02	70	395	115	1,8
03	70	595	115	2,7

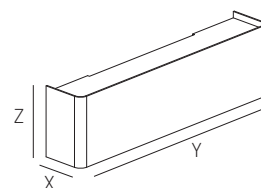

Min and Max room temperature: -20°+45° C.

Zoe



Decorative wall mounted lighting fitting

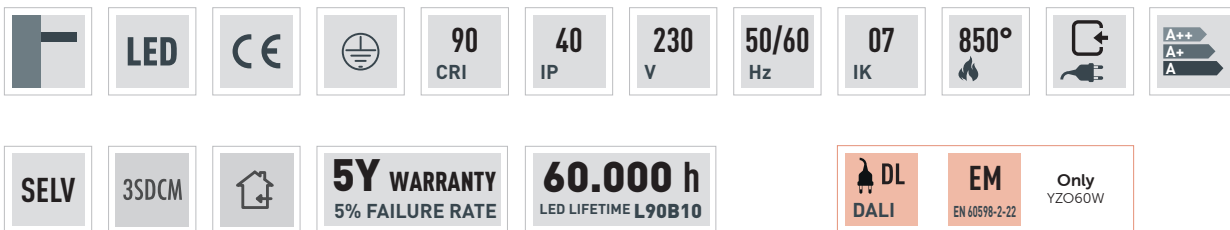

On request

IT

Apparecchio decorativo per installazione a parete. Corpo in acciaio al carbonio pressopiegato. Sorgente luminosa LED multichip. Verniciatura con polveri epossidiche antigraffio. Schermo di chiusura in policarbonato opalino. Alimentatore incorporato.

ES

Luminaria decorativa para instalación en pared. Cuerpo de acero al carbono plegado. Fuente de iluminación LED. Barnizado con polvo epoxi anti-rayado. Difusor de policarbonato opal. Balasto integrado.

EN

Decorative wall lighting fitting. Bent carbon steel body. Multichip LED light source. Painted with scratch-resistant epoxy powders. Opal polycarbonate closing reflector. Built-in driver.

DE

Dekoratives Wandbeleuchtungsgerät. Körper aus pressgeformtem Kohlenstoffstahl. LED-Lichtquelle. Lackiert mit kratzfesten Epoxidpulvern. Abdeckschirm aus opalem Polycarbonat. Integrierter Treiber.

FR

Appareil décoratifs au mur. Corps en acier au carbone plies à la presse. Source lumineuse LED. Finition de peinture en poudre époxy anti-rayures. Écran de fermeture en polycarbonate opal. Alimentation avec driver intégré.



ZOE 4000 K

Code	Size	Lumen Out	Watt Tot	K	Beam angle	Driver Type	Driver no.	Colour
DIRECT + INDIRECT EMISSION (D+I)								
YZO23N	01	1735	22	4000	D	ON/OFF	1	○
YZO40N	02	3315	42	4000	D	ON/OFF	1	○
YZO60N	03	5125	65	4000	D	ON/OFF	1	○

ZOE 3000 K

Code	Size	Lumen Out	Watt Tot	K	Beam angle	Driver Type	Driver no.	Colour
DIRECT + INDIRECT EMISSION (D+I)								
YZO23W	01	1610	22	3000	D	ON/OFF	1	○
YZO40W	02	3070	42	3000	D	ON/OFF	1	○
YZO60W	03	4745	65	3000	D	ON/OFF	1	○

ZOE STANDARD COLOUR SELECTION

● **WI** | White Irazu ● **BLL** | Black Lava

ZOE ON REQUEST COLOUR SELECTION

● **BF** | Beige Futuna ● **SB** | Silver Bombalai ● **GK** | Gold Karkar
 ● **BL** | Bronze Lario ● **RR** | Rust Rame ● **BT** | Blue Telica

ZOE BEAM ANGLE | DIMENSIONS

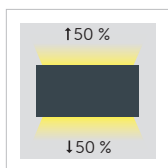

Size	X [mm]	Y [mm]	Z [mm]	Kg
01	70	225	115	1,1
02	70	395	115	1,8
03	70	595	115	2,7

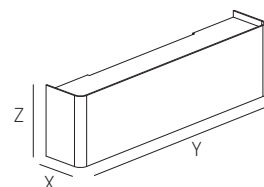

Min and Max room temperature: -20°+45° C.





Talé



Talè m



Decorative wall mounted lighting fitting



On request

IT

Apparecchio decorativo per installazione a parete. Base portacablaggio con sorgente luminosa LED multichip e schermo di chiusura in policarbonato opalino. Frontale in acciaio al carbonio pressopiegato intercambiabile con fissaggio magnetico. Verniciatura con polveri epossidiche antigraffio. Alimentatore incorporato.

ES

Luminaria decorativa para instalación en pared. Base soporte de cableado con fuente de iluminación LED multichip y difusor de policarbonato opal. Panel frontal de carbono plegado a presión intercambiable con sistema de fijación magnético. Barnizado con polvo epoxi anti-rayado. Balasto integrado.

EN

Decorative wall lighting fitting. Gear plate with multichip led lighting source and opal polycarbonate closing reflector. Interchangeable bent carbon steel front with magnetic fixing. Painted with scratch-resistant epoxy powders. Built-in driver.

DE

Dekoratives Wandbeleuchtungsgerät. Verdrahtungsbasis mit multichip LEDLeuchtmittel und Abdeckschirm aus opalem Polycarbonat. Auswechselbare Vorderer aus pressgeformtem Kohlenstoffstahl mit magnetischer Befestigung. Lackiert mit kratzfesten Epoxidpulvern. Integrierter Treiber.

FR

Appareil décoratifs au mur. Socle de câblage avec source lumineuse LED et écran de fermeture en polycarbonate opale. Avant en acier au carbon interchangeable avec fixation magnétique. Finition de peinture en poudre époxy anti-rayures. Alimentation avec driver intégré.



01



02



03

TALÈ M BASE 4000 K

Code	Size	Lumen Out	Watt Tot	K	Beam angle	Driver Type	Driver no.
DIRECT + INDIRECT EMISSION (D+I)							
YTAM14N	01	3160	37	4000	D	ON/OFF	1
YTAM17N	02	3925	46	4000	D	ON/OFF	1
YTAM32N	03	4695	55	4000	D	ON/OFF	1

TALÈ M BASE 3000 K

Code	Size	Lumen Out	Watt Tot	K	Beam angle	Driver Type	Driver no.
DIRECT + INDIRECT EMISSION (D+I)							
YTAM14W	01	2925	37	3000	D	ON/OFF	1
YTAM17W	02	3635	46	3000	D	ON/OFF	1
YTAM32W	03	4345	55	3000	D	ON/OFF	1

TALÈ M MAGNETIC COVER

Code	Size	Colour
YTAFM145	01	○
YTAFM175	02	○
YTAFM325	03	○

TALÈ M STANDARD COLOUR SELECTION

● **WI** | White Irazu ● **BLL** | Black Lava

TALÈ M ON REQUEST COLOUR SELECTION

● **BF** | Beige Futuna ● **SB** | Silver Bombalai ● **GK** | Gold Karkar
 ● **BL** | Bronze Lario ● **RR** | Rust Rame ● **BT** | Blue Telica

TALÈ M BEAM ANGLE | DIMENSIONS

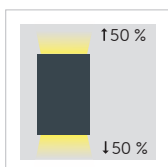

Size	X (mm)	Y (mm)	Z (mm)	Kg
01	85	120	145	1,0
02	85	120	175	1,3
03	125	180	325	2,5

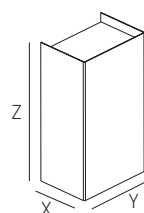

Min and Max room temperature: -20°+45° C.

Talè



Decorative wall mounted lighting fitting

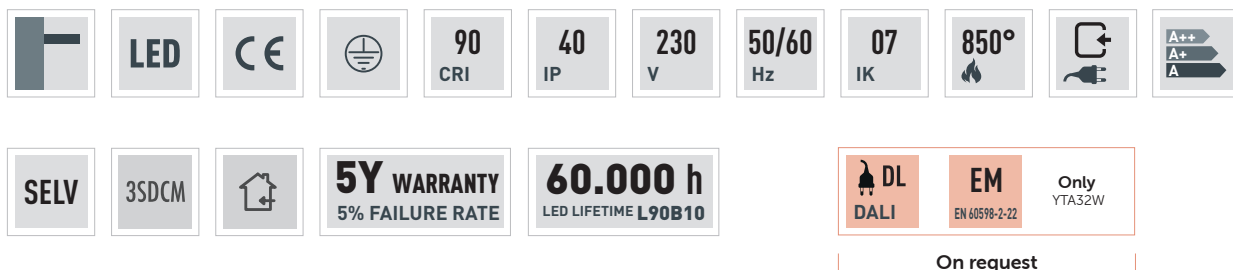

IT

Apparecchio decorativo per installazione a parete. Corpo in acciaio al carbonio pressopiegato. Sorgente luminosa LED multichip. Verniciatura con polveri epossidiche antigraffio. Schermo di chiusura in policarbonato opalino. Alimentatore incorporato.

ES

Luminaria decorativa para instalación en pared. Cuerpo de acero al carbono plegado. Fuente de iluminación LED. Barnizado con polvo epoxi anti-rayado. Difusor de policarbonato opal. Balasto integrado.

EN

Decorative wall lighting fitting. Bent carbon steel body. Multichip LED light source. Painted with scratch-resistant epoxy powders. Opal polycarbonate closing reflector. Built-in driver.

DE

Dekoratives Wandbeleuchtungsgerät. Körper aus pressgeformtem Kohlenstoffstahl. LED-Lichtquelle. Lackiert mit kratzfesten Epoxidpulvern. Abdeckschirm aus opalem Polycarbonat. Integrierter Treiber.

FR

Appareil décoratifs au mur. Corps en acier au carbone plies à la presse. Source lumineuse LED. Finition de peinture en poudre époxy anti-rayures. Écran de fermeture en polycarbonate opal. Alimentation avec driver intégré.



TALÈ 4000 K

Code	Size	Lumen Out	Watt Tot	K	Beam angle	Driver Type	Driver no.	Colour
DIRECT + INDIRECT EMISSION (D+I)								
YTA14N	01	3160	37	4000	D	ON/OFF	1	○
YTA17N	02	3925	46	4000	D	ON/OFF	1	○
YTA32N	03	4695	55	4000	D	ON/OFF	1	○

TALÈ 3000 K

Code	Size	Lumen Out	Watt Tot	K	Beam angle	Driver Type	Driver no.	Colour
DIRECT + INDIRECT EMISSION (D+I)								
YTA14W	01	2925	37	3000	D	ON/OFF	1	○
YTA17W	02	3635	46	3000	D	ON/OFF	1	○
YTA32W	03	4345	55	3000	D	ON/OFF	1	○

TALÈ STANDARD COLOUR SELECTION

- **WI** | White Irazu
- **BLL** | Black Lava

TALÈ ON REQUEST COLOUR SELECTION

- **BF** | Beige Futuna
- **SB** | Silver Bombalai
- **GK** | Gold Karkar
- **BL** | Bronze Lario
- **RR** | Rust Rame
- **BT** | Blue Telica

TALÈ BEAM ANGLE | DIMENSIONS

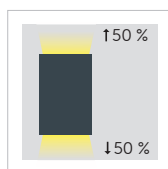

Size	X [mm]	Y [mm]	Z [mm]	Kg
01	85	120	145	1,0
02	85	120	175	1,3
03	125	180	325	2,5

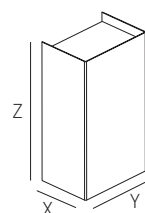

Min and Max room temperature: -20°+45° C.





Ester



Ester



Decorative ceiling or wall mounted lighting fitting

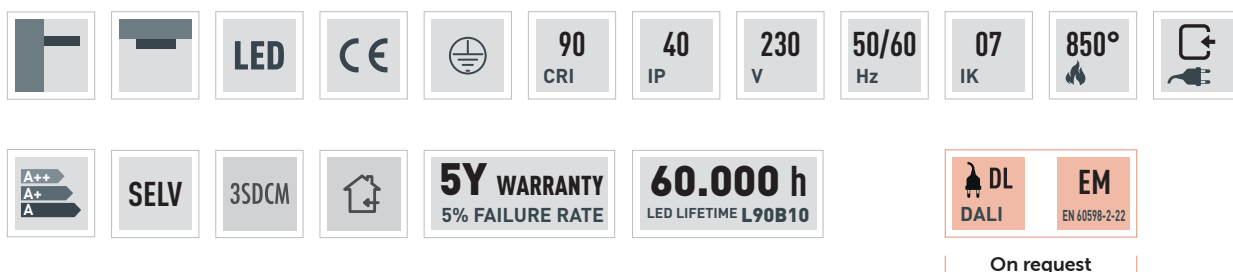

On request

IT

Apparecchio decorativo per installazione a parete o plafone. Corpo in estruso di alluminio. Sorgente luminosa LED multichip. Verniciatura con polveri epossidiche antigraffio. Schermo di chiusura in policarbonato opalino. Alimentatore incorporato.

ES

Luminaria decorativa para instalación en pared y techo. Cuerpo de aluminio extruido. Fuente de iluminación LED. Barnizado con polvo epoxi anti-rayado. Difusor de policarbonato opal. Balasto integrado.

EN

Decorative wall or ceiling lighting fitting. Extruded aluminium body. LED light source. Painted with scratch-resistant epoxy powders. Opal polycarbonate closing reflector. Built-in driver.

DE

Dekoratives Wand- und Deckenbeleuchtungsgerät. Extrudierter Aluminiumkörper. LED-Lichtquelle. Lackiert mit kratzfesten Epoxidpulvern. Abdeckschirm aus opalem Polycarbonat. Integrierter Treiber.

FR

Appareil décoratifs au mur ou plafond. Corps en aluminium extrudé. Source lumineuse LED. Finition de peinture en poudre époxy anti-rayures. Écran de fermeture en polycarbonate opal. Alimentation avec driver intégré.

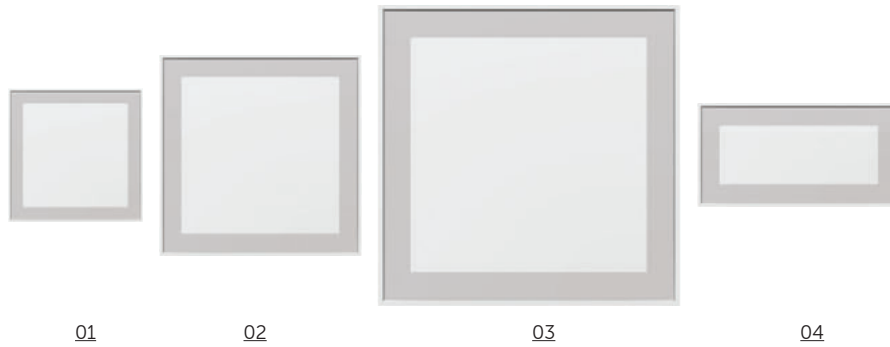

ESTER 4000 K

Code	Size	Lumen Out	Watt Tot	K	Beam angle	Driver Type	Driver no.	Colour
YES40N	01	1150	14	4000	D	ON/OFF	1	○
YES60N	02	4515	55	4000	D	ON/OFF	1	○
YES90N	03	6815	83	4000	D	ON/OFF	2	○
YES30N	04	2300	28	4000	D	ON/OFF	2	○

ESTER 3000 K

Code	Size	Lumen Out	Watt Tot	K	Beam angle	Driver Type	Driver no.	Colour
YES40W	01	1065	14	3000	D	ON/OFF	1	○
YES60W	02	4180	55	3000	D	ON/OFF	1	○
YES90W	03	6310	83	3000	D	ON/OFF	2	○
YES30W	04	2130	28	3000	D	ON/OFF	2	○

ESTER STANDARD COLOUR SELECTION

● **WI** | White Irazu ● **BLL** | Black Lava

ESTER ON REQUEST COLOUR SELECTION

● **BF** | Beige Futuna ● **SB** | Silver Bombalai ● **GK** | Gold Karkar
 ● **BL** | Bronze Lario ● **RR** | Rust Rame ● **BT** | Blue Telica

ESTER BEAM ANGLE | DIMENSIONS

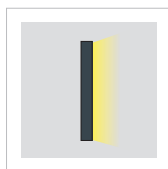

Size	X [mm]	Y [mm]	Z [mm]	Kg
01	400	400	78	4,2
02	600	600	78	7,2
03	900	900	78	14,0
04	300	600	78	4,6

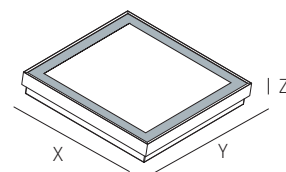

Min and Max room temperature: -20°+45° C.





Дуду



Dudu

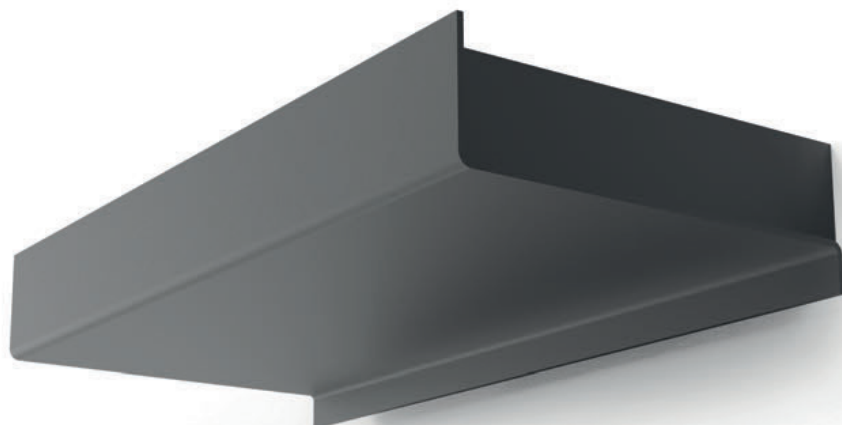

Decorative wall mounted lighting fitting

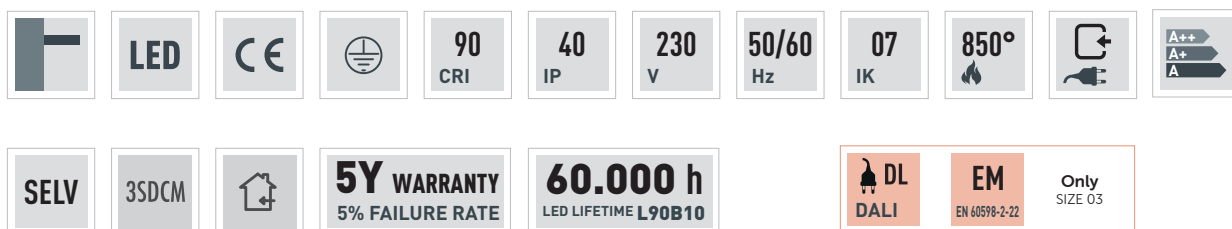

On request

IT

Apparecchio decorativo per installazione a parete. Corpo in acciaio al carbonio pressopiegato. Sorgente luminosa LED multichip. Verniciatura con polveri epossidiche antigraffio. Schermo di chiusura in policarbonato microprismato. Alimentatore incorporato.

ES

Luminaria decorativa para instalación en pared. Cuerpo de acero al carbono plegado. Fuente de iluminación LED. Barnizado con polvo epoxi anti-rayado. Difusor de policarbonato microprismático. Balasto integrado.

EN

Decorative wall lighting fitting. Bent carbon steel body. Multichip LED light source. Painted with scratch-resistant epoxy powders. Microprismatic polycarbonate closing reflector. Built-in driver.

DE

Dekoratives Wandbeleuchtungsgerät. Körper aus pressgeformtem Kohlenstoffstahl. LED-Lichtquelle. Lackiert mit kratzfesten Epoxidpulvern. Abdeckschirm aus mikroprismatischem Polycarbonat. Integrierter Treiber.

FR

Appareil décoratifs au mur. Corps en acier au carbone plies à la presse. Source lumineuse LED. Finition de peinture en poudre époxy anti-rayures. Écran de fermeture en polycarbonate microprismatique. Alimentation avec driver intégré.



DUDU 4000 K

Code	Size	Lumen Out	Watt Tot	K	Beam angle	Driver Type	Driver no.	Colour
YDU23N	01	2017	21	4000	D	ON/OFF	1	○
YDU40N	02	4122	42	4000	D	ON/OFF	1	○
YDU60N	03	6314	63	4000	D	ON/OFF	1	○

DUDU 3000 K

Code	Size	Lumen Out	Watt Tot	K	Beam angle	Driver Type	Driver no.	Colour
YDU23W	01	1868	21	3000	D	ON/OFF	1	○
YDU40W	02	3817	42	3000	D	ON/OFF	1	○
YDU60W	03	5846	63	3000	D	ON/OFF	1	○

DUDU STANDARD COLOUR SELECTION

● **WI** | White Irazu ● **BLL** | Black Lava

DUDU ON REQUEST COLOUR SELECTION

● **BF** | Beige Futuna ● **SB** | Silver Bombalai ● **GK** | Gold Karkar
 ● **BL** | Bronze Lario ● **RR** | Rust Rame ● **BT** | Blue Telica

DUDU BEAM ANGLE | DIMENSIONS

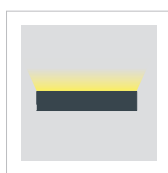

Size	X (mm)	Y (mm)	Z (mm)	J (mm)	K (mm)	Kg
01	110	230	40	10	30	0,8
02	110	395	40	10	30	1,4
03	110	595	40	10	30	2,1

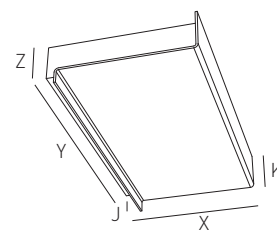

Min and Max room temperature: -20°+45° C.





DOSI



Dosi

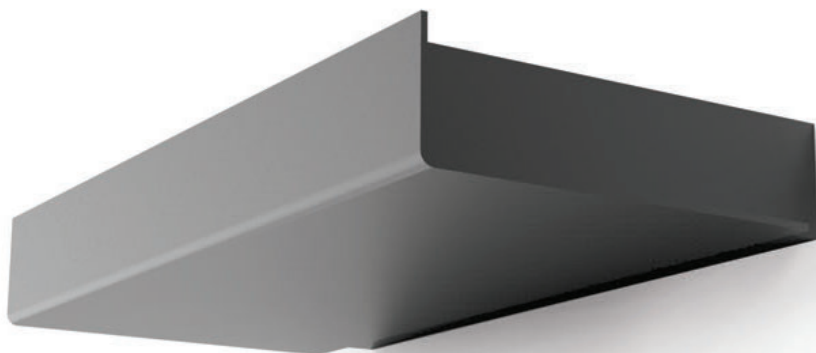

Decorative wall mounted lighting fitting

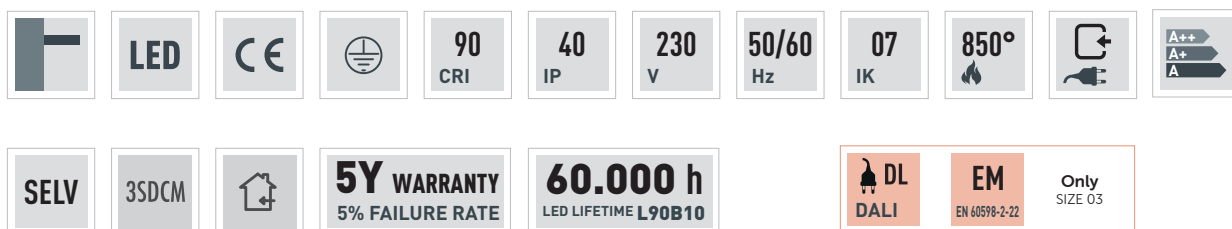

On request

IT

Apparecchio decorativo per installazione a parete. Corpo in acciaio al carbonio pressopiegato. Sorgente luminosa LED multichip. Verniciatura con polveri epossidiche antigraffio. Schermo di chiusura in policarbonato microprismato. Alimentatore incorporato.

ES

Luminaria decorativa para instalación en pared. Cuerpo de acero al carbono plegado. Fuente de iluminación LED. Barnizado con polvo epoxi anti-rayado. Difusor de policarbonato microprismático. Balasto integrado.

EN

Decorative wall lighting fitting. Bent carbon steel body. Multichip LED light source. Painted with scratch-resistant epoxy powders. Microprismatic polycarbonate closing reflector. Built-in driver.

DE

Dekoratives Wandbeleuchtungsgerät. Körper aus pressgeformtem Kohlenstoffstahl. LED-Lichtquelle. Lackiert mit kratzfesten Epoxidpulvern. Abdeckschirm aus mikroprismatischem Polycarbonat. Integrierter Treiber.

FR

Appareil décoratifs au mur. Corps en acier au carbone plies à la presse. Source lumineuse LED. Finition de peinture en poudre époxy anti-rayures. Écran de fermeture en polycarbonate microprismatique. Alimentation avec driver intégré.



DOSI 4000 K

Code	Size	Lumen Out	Watt Tot	K	Beam angle	Driver Type	Driver no.	Colour
YDO23N	01	2017	21	4000	D	ON/OFF	1	○
YDO40N	02	4122	42	4000	D	ON/OFF	1	○
YDO60N	03	6314	63	4000	D	ON/OFF	1	○

DOSI 3000 K

Code	Size	Lumen Out	Watt Tot	K	Beam angle	Driver Type	Driver no.	Colour
YDO23W	01	1868	21	3000	D	ON/OFF	1	○
YDO40W	02	3817	42	3000	D	ON/OFF	1	○
YDO60W	03	5846	63	3000	D	ON/OFF	1	○

DOSI STANDARD COLOUR SELECTION

● **WI** | White Irazu ● **BLL** | Black Lava

DOSI ON REQUEST COLOUR SELECTION

● **BF** | Beige Futuna ● **SB** | Silver Bombalai ● **GK** | Gold Karkar
 ● **BL** | Bronze Lario ● **RR** | Rust Rame ● **BT** | Blue Telica

DOSI BEAM ANGLE | DIMENSIONS

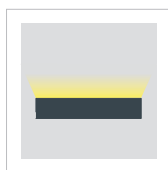

Size	X (mm)	Y (mm)	Z (mm)	K (mm)	Kg
01	110	230	30	40	0,8
02	110	395	30	40	1,4
03	110	595	30	40	2,1

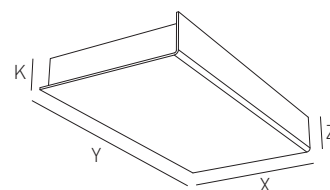

Min and Max room temperature: -20°+45° C.





Gina



Gina

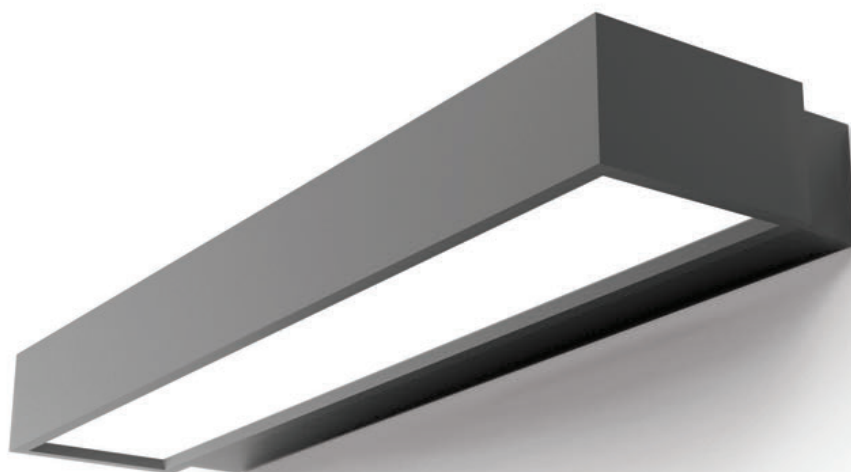

Decorative wall mounted lighting fitting

	LED	CE		90 CRI	40 IP	230 V	50/60 Hz	07 IK	850° 		
SELV	3SDCM		5Y WARRANTY 5% FAILURE RATE	60.000 h LED LIFETIME L90B10	DL DALI		EM EN 60598-2-22	Only YG180W		On request	

IT

Apparecchio decorativo per installazione a parete. Corpo in estruso di alluminio. Sorgente luminosa LED multichip. Verniciatura con polveri epossidiche antigraffio. Schermo di chiusura in policarbonato opale. Alimentatore incorporato.

EN

Decorative wall lighting fitting. Extruded aluminium body. LED light source. Painted with scratch-resistant epoxy powders. Opal polycarbonate closing reflector. Built-in driver.

FR

Appareil décoratifs au mur. Corps en aluminium extrudé. Source lumineuse LED. Finition de peinture en poudre époxy anti-rayures. Écran de fermeture en polycarbonate opal. Alimentation avec driver intégré.

ES

Luminaria decorativa para instalación en pared. Cuerpo de aluminio extruido. Fuente de iluminación LED. Barnizado con polvo epoxi anti-rayado. Difusor de policarbonato opal. Balasto integrado.

DE

Dekoratives Wandbeleuchtungsgerät. Extrudierter Aluminiumkörper. LED-Lichtquelle. Lackiert mit kratzfesten Epoxidpulvern. Abdeckschirm aus opalem Polycarbonat. Integrierter Treiber.



GINA 4000 K

Code	Size	Lumen Out	Watt Tot	K	Beam angle	Driver Type	Driver no.	Colour
DIRECT + INDIRECT EMISSION (D+I)								
YGI18N	01	620	9	4000	D	ON/OFF	1	○
YGI41N	02	1180	12	4000	D	ON/OFF	1	○
YGI80N	03	2380	24	4000	D	ON/OFF	1	○

GINA 3000 K

Code	Size	Lumen Out	Watt Tot	K	Beam angle	Driver Type	Driver no.	Colour
DIRECT + INDIRECT EMISSION (D+I)								
YGI18W	01	580	9	3000	D	ON/OFF	1	○
YGI41W	02	1100	12	3000	D	ON/OFF	1	○
YGI80W	03	2200	24	3000	D	ON/OFF	1	○

GINA STANDARD COLOUR SELECTION

● **WI** | White Irazu ● **BLL** | Black Lava

GINA ON REQUEST COLOUR SELECTION

● **BF** | Beige Futuna ● **SB** | Silver Bombalai ● **GK** | Gold Karkar
 ● **BL** | Bronze Lario ● **RR** | Rust Rame ● **BT** | Blue Telica

GINA BEAM ANGLE | DIMENSIONS

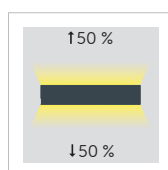

Size	X [mm]	Y [mm]	Z [mm]	K [mm]	J [mm]	Kg
01	110	180	45	30	80	0,6
02	110	410	45	30	80	1,4
03	110	800	45	30	80	2,4

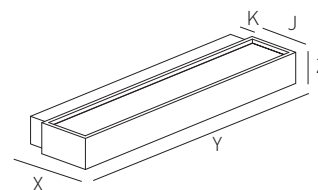

Min and Max room temperature: -20°+45° C.





Mali



Mali



Decorative wall mounted lighting fitting

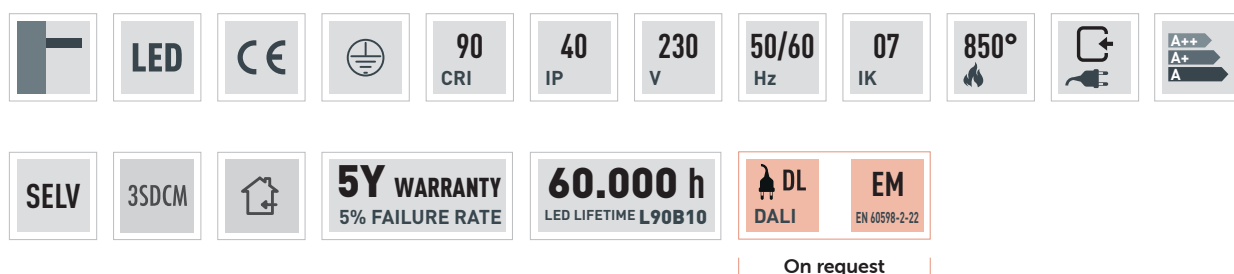

On request

IT

Apparecchio decorativo per installazione a parete o plafone. Corpo in acciaio al carbonio calandrato e pressopiegato, cod (S) liscio, cod (AM) con feritoie. Sorgente luminosa LED multichip. Verniciatura con polveri epossidiche antigraffio. Schermo di chiusura in policarbonato opalino. Alimentatore incorporato.

ES

Luminaria decorativa para instalación en pared y techo. Cuerpo de acero al carbono plegado y calandrado, código (S) con difusor liso, código (AM) con difusor radiado. Fuente de iluminación LED. Barnizado con polvo epoxi anti-rayado. Difusor de policarbonato opal. Balasto integrado.

EN

Decorative wall or ceiling lighting fitting. Bent and calendered carbon steel body, code (S) smooth, code (AM) with loopholes. LED light source. Painted with scratch-resistant epoxy powders. Opal polycarbonate closing reflector. Built-in driver.

DE

Dekoratives Wand- und Deckenbeleuchtungsgerät. Körper aus pressgeformtem und kalandriertem Kohlenstoffstahl, Kode (S) glatt, Kode (AM) mit Gittern. LED-Lichtquelle. Lackiert mit kratzfesten Epoxidpulvern. Abdeckschirm aus opalem Polycarbonat. Integrierter Treiber.

FR

Appareil décoratifs au mur ou plafond. Corps en acier au carbone courbé et calandré, code (S) lisse, code (AM) avec persienne. Source lumineuse LED. Finition de peinture en poudre époxy anti-rayures. Écran de fermeture en polycarbonate opal. Alimentation avec driver intégré.

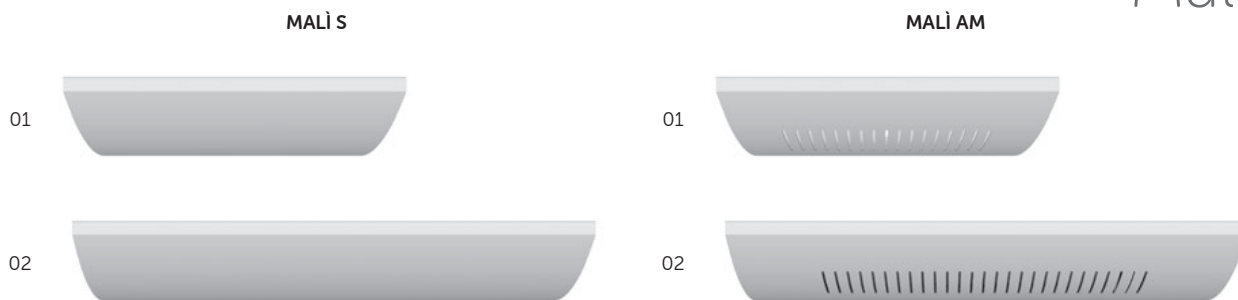

MALI S 4000 K

Code	Size	Lumen Out	Watt Tot	K	Beam angle	Driver Type	Driver no.	Colour
YMAS36N	01	2225	22	4000	D	ON/OFF	1	○
YMAS60N	02	3335	33	4000	D	ON/OFF	1	○

MALI S 3000 K

Code	Size	Lumen out	Watt Tot	K	Beam angle	Driver Type	Driver no.	Colour
YMAS36W	01	2050	22	3000	D	ON/OFF	x	○
YMAS60W	02	3070	33	3000	D	ON/OFF	x	○

MALI AM 4000 K

Code	Size	Lumen Out	Watt Tot	K	Beam angle	Driver Type	Driver no.	Colour
YMAM36N	01	2225	22	4000	D	ON/OFF	1	○
YMAM60N	02	3335	33	4000	D	ON/OFF	1	○

MALI AM 3000 K

Code	Size	Lumen Out	Watt Tot	K	Beam angle	Driver Type	Driver no.	Colour
YMAM36W	01	2050	22	3000	D	ON/OFF	x	○
YMAM60W	02	3070	33	3000	D	ON/OFF	x	○

MALI S-AM STANDARD COLOUR SELECTION ● WI | White Irazu ● BLL | Black Lava

MALI S-AM ON REQUEST COLOUR SELECTION ● BF | Beige Futuna ● SB | Silver Bombalai ● GK | Gold Karkar
● BL | Bronze Lario ● RR | Rust Rame ● BT | Blue Telica

MALI S-AM BEAM ANGLE | DIMENSIONS

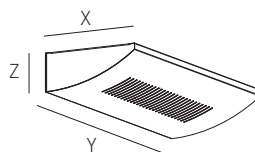
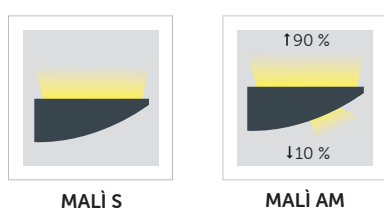

Size	X [mm]	Y [mm]	Z [mm]	Kg
01	235	360	92	3,5
02	235	600	92	6,8

Min and Max room temperature: -20°+45° C.





Norton



Norton

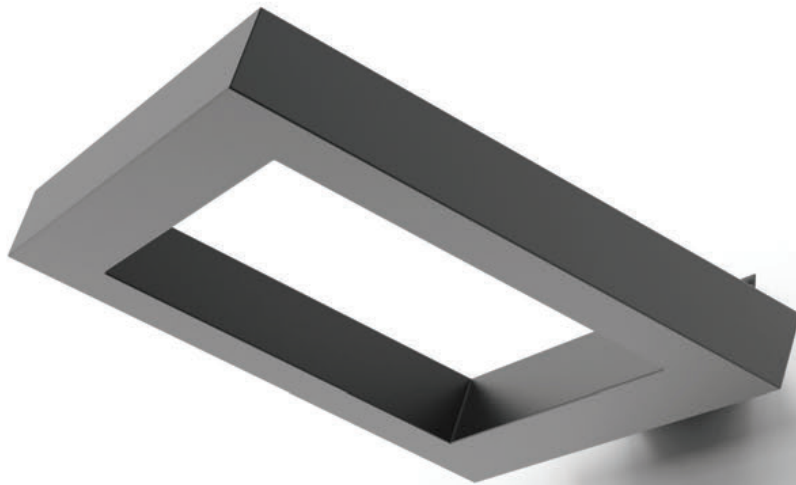

Decorative wall mounted lighting fitting

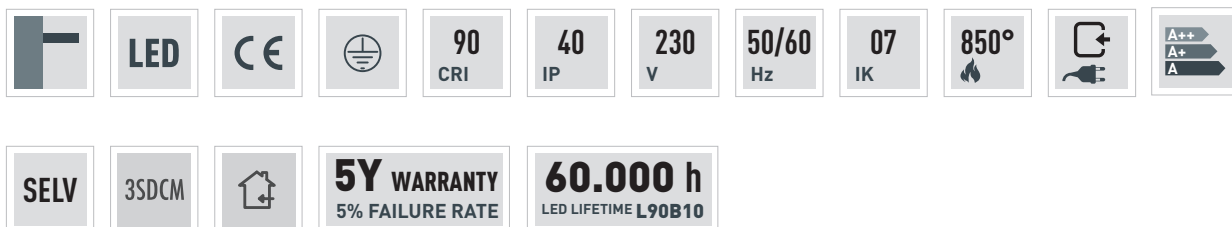

IT

Apparecchio decorativo per installazione a parete con inclinazione regolabile. Corpo in pressofusione di alluminio. Sorgente luminosa LED multichip. Verniciatura con polveri epossidiche antigraffio. Schermo di chiusura in policarbonato microprismato. Alimentatore incorporato.

ES

Luminaria decorativa para instalación en pared con inclinación regulable. Cuerpo de aluminio fundido a presión. Fuente de iluminación LED. Barnizado con polvo epoxi anti-rayado. Difusor de policarbonato microprismático. Balasto integrado.

EN

Decorative lighting fitting for wall installation with adjustable inclination. Die-cast aluminium body. Multichip LED light source. Painted with scratch-resistant epoxy powders. Microprismatic polycarbonate closing reflector. Built-in driver.

DE

Dekoratives Wandbeleuchtungsgerät mit einstellbarer Neigung. Körper aus Aluminiumdruckguss. LED-Lichtquelle. Lackiert mit kratzfesten Epoxidpulvern. Abdeckschirm aus mikroprismatischem Polycarbonat. Integrierter Treiber.

FR

Appareils décoratif pour l'installation sur le mur avec inclinaison réglable. Corps en aluminium moulé sous pression. Source lumineuse LED. Finition de peinture en poudre époxy anti-rayures. Écran de fermeture en polycarbonate microprismatique. Alimentation avec driver intégré.



NORTON

Code	Size	Lumen Out	Watt Tot	K	Beam angle	Driver Type	Driver no.	Colour
YNO29W	01	1600	14	W	D	ON/OFF	1	○

○ NORTON COLOUR SELECTION

○ BI | Bianco

● NE | Nero

NORTON BEAM ANGLE | DIMENSIONS

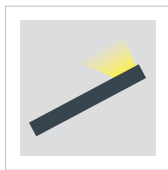

Size	X (mm)	Y (mm)	Z (mm)	Kg
01	290	40	290	1,6

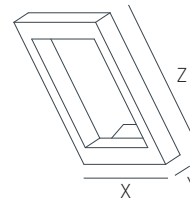

Min and Max room temperature: -20°+45° C.





Trem



Trem

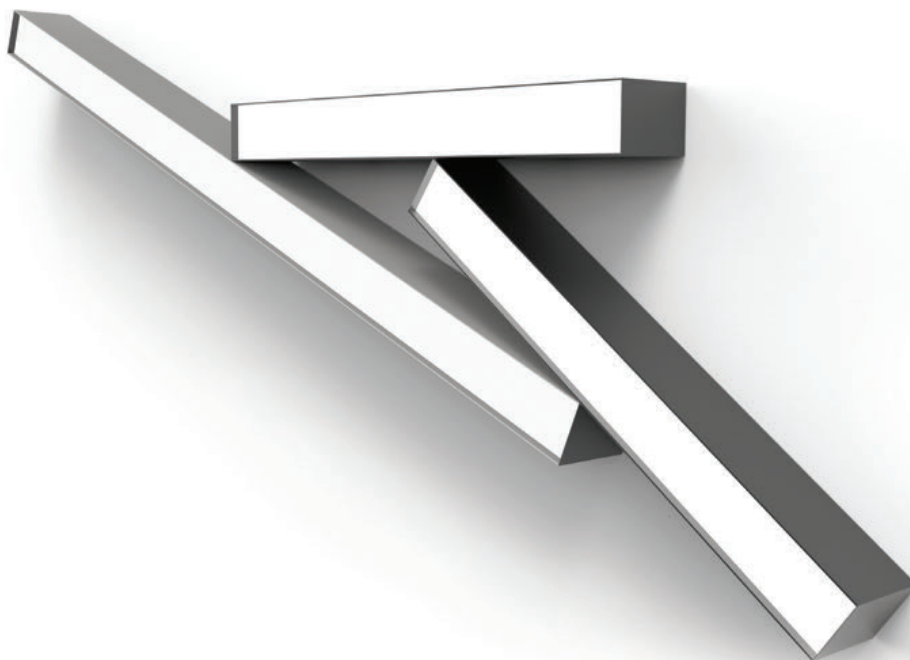

Decorative or ceiling wall mounted lighting fitting

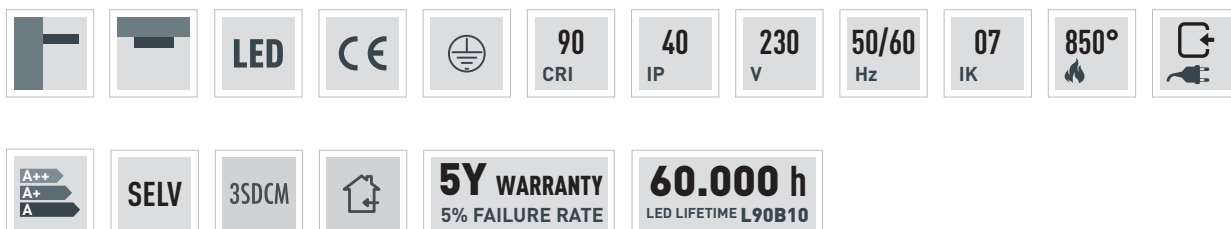

IT

Apparecchio decorativo per installazione a parete o plafone. Corpo in acciaio al carbonio pressopiegato. Sorgente luminosa LED multichip. Verniciatura con polveri epossidiche antigraffio. Schermo di chiusura in policarbonato opale. Alimentatore incorporato.

ES

Luminaria decorativa para instalación en pared y techo. Cuerpo de acero al carbono plegado. Fuente de iluminación LED. Barnizado con polvo epoxi anti-rayado. Difusor de policarbonato opal. Balasto integrado.

EN

Apparecchio decorativo per installazione a parete o plafone. Corpo in acciaio al carbonio pressopiegato. Sorgente luminosa LED multichip. Verniciatura con polveri epossidiche antigraffio. Schermo di chiusura in policarbonato opale. Alimentatore incorporato.

DE

Dekoratives Wand- und Deckenbeleuchtungsgerät. Körper aus pressgeformtem Kohlenstoffstahl. LED-Lichtquelle. Lackiert mit kratzfesten Epoxidpulvern. Abdeckschirm aus opalem Polycarbonat. Integrierter Treiber.

FR

Appareil décoratifs au mur ou plafond. Corps en acier au carbone plies à la presse. Source lumineuse LED. Finition de peinture en poudre époxy anti-rayures. Écran de fermeture en polycarbonate opal. Alimentation avec driver intégré.



TREM 4000 K

Code	Size	Lumen Out	Watt Tot	K	Beam angle	Driver Type	Driver no.	Colour
YTR15N	01	6622	61	4000	D	ON/OFF	2	○

TREM 3000 K

Code	Size	Lumen Out	Watt Tot	K	Beam angle	Driver Type	Driver no.	Colour
YTR15W	01	6132	61	3000	D	ON/OFF	2	○

TREM STANDARD COLOUR SELECTION

● **WI** | White Irazu ● **BLL** | Black Lava

TREM ON REQUEST COLOUR SELECTION

● **BF** | Beige Futuna ● **SB** | Silver Bombalai ● **GK** | Gold Karkar
 ● **BL** | Bronze Lario ● **RR** | Rust Rame ● **BT** | Blue Telica

TREM BEAM ANGLE | DIMENSIONS

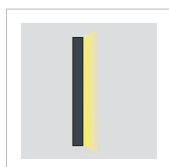

Size	X [mm]	Y [mm]	Z [mm]	Kg
01	1500	90	500	9,0

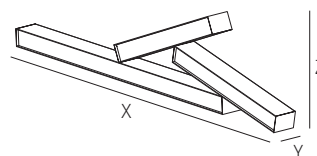

Min and Max room temperature: -20°+45° C.





P1a



Pla



Decorative wall mounted lighting fitting

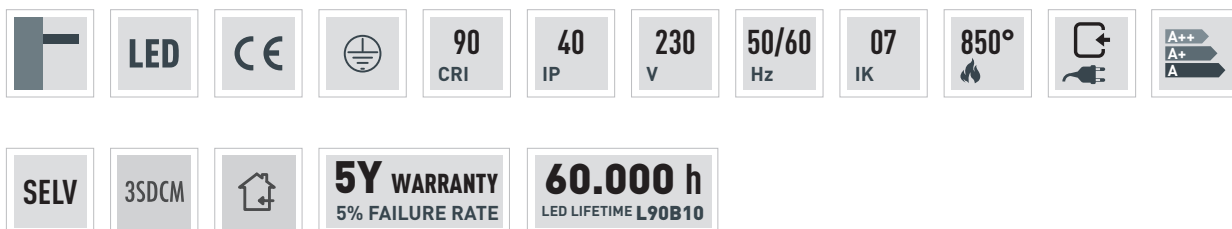

IT

Apparecchio decorativo per installazione a parete. Corpo in acciaio al carbonio pressopiegato. Sorgente luminosa LED multichip. Verniciatura con polveri epossidiche antigraffio. Schermo di chiusura in policarbonato opalino. Alimentatore incorporato.

ES

Luminaria decorativa para instalación en pared. Cuerpo de acero al carbono plegado. Fuente de iluminación LED. Barnizado con polvo epoxi anti-rayado. Difusor de policarbonato opal. Balasto integrado.

EN

Decorative wall lighting fitting. Bent carbon steel body. Multichip LED light source. Painted with scratch-resistant epoxy powders. Opal polycarbonate closing reflector. Built-in driver.

DE

Dekoratives Wandbeleuchtungsgerät. Körper aus pressgeformtem Kohlenstoffstahl. LED-Lichtquelle. Lackiert mit kratzfesten Epoxidpulvern. Abdeckschirm aus opalem Polycarbonat. Integrierter Treiber.

FR

Appareil décoratifs au mur. Corps en acier au carbone plies à la presse. Source lumineuse LED. Finition de peinture en poudre époxy anti-rayures. Écran de fermeture en polycarbonate opal. Alimentation avec driver intégré.

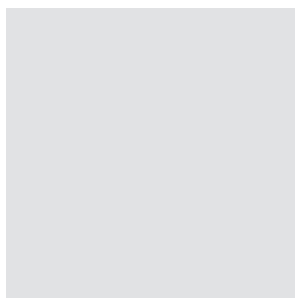

PLA 4000 K

Code	Size	Lumen Out	Watt Tot	K	Beam angle	Driver Type	Driver no.	Colour
YPL30N	01	6535	65	4000	D	ON/OFF	1	○

PLA 3000 K

Code	Size	Lumen Out	Watt Tot	K	Beam angle	Driver Type	Driver no.	Colour
YPL30W	01	6051	65	3000	D	ON/OFF	1	○

○ PLA COLOUR SELECTION

○ BI | Bianco

● NE | Nero

PLA BEAM ANGLE | DIMENSIONS

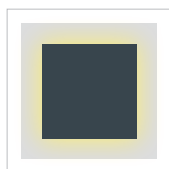

Size	X [mm]	Y [mm]	Z [mm]	Kg
01	300	54	300	2,7



Min and Max room temperature: -20°+45° C.





Bomboei m



Bombeim



Decorative wall mounted lighting fitting

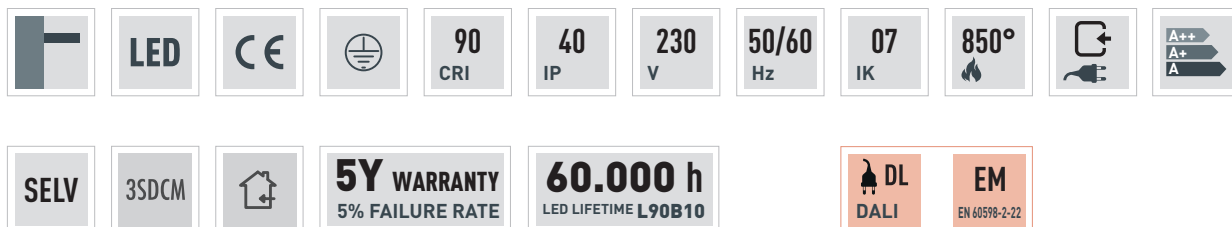

On request

IT

Apparecchio decorativo per installazione a parete. Base portacablaggio con sorgente luminosa LED multichip e schermo di chiusura in policarbonato opalino. Frontale in alluminio tornato intercambiabile con fissaggio magnetico. Verniciatura con polveri epossidiche antigraffio. Alimentatore incorporato.

ES

Luminaria decorativa para instalación en pared. Base soporte de cableado con fuente de iluminación LED multichip y difusor de policarbonato opal. Panel frontal de aluminio torneado intercambiabile con sistema de fijación magnético. Barnizado con polvo epoxi anti-rayado. Balasto integrado.

EN

Decorative wall lighting fitting. Gear plate with multichip led lighting source and opal polycarbonate closing reflector. Interchangeable turned aluminum front with magnetic fixing. Painted with scratch-resistant epoxy powders. Built-in driver.

DE

Dekoratives Wandbeleuchtungsgerät. Verdrahtungsbasis mit multichip LEDLeuchtmittel und Abdeckschirm aus opalem Polycarbonat. Auswechselbare Vordere aus pressgeformtem Kohlenstoffstahl mit magnetischer Befestigung. Lackiert mit kratzfesten Epoxidpulvern. Integrierter Treiber.

FR

Appareil décoratifs au mur. Socle de câblage avec source lumineuse LED et écran de fermeture en polycarbonate opale. Avant en aluminium tourné interchangeable avec fixation magnétique. Finition de peinture en poudre époxy anti-rayures. Alimentation avec driver intégré.

Bombei m



BOMBEI M BASE 4000 K

Code	Size	Lumen Out	Watt Tot	K	Beam angle	Driver Type	Driver no.
YBOM39N	01	1724	21	4000	D	ON/OFF	1

BOMBEI M BASE 3000 K

Code	Size	Lumen Out	Watt Tot	K	Beam angle	Driver Type	Driver no.
YBOM39W	01	1596	21	3000	D	ON/OFF	1

BOMBEI M MAGNETIC COVER

Code	Size	Colour
YBOFM385	01	○

BOMBEI M STANDARD COLOUR SELECTION ● WI | White Irazu ● BLL | Black Lava

BOMBEI M ON REQUEST COLOUR SELECTION ● BF | Beige Futuna ● SB | Silver Bombalai ● GK | Gold Karkar
● BL | Bronze Lario ● RR | Rust Rame ● BT | Blue Telica

BOMBEI M BEAM ANGLE | DIMENSIONS

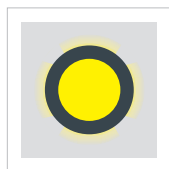

Size	X (mm)	Y (mm)	Z (mm)	Kg
01	∅ 385	∅ 305	53	1,9

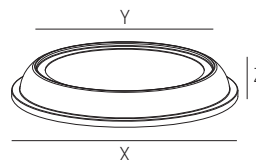





FLOOR





SOOO pod



SOO pd



Floor decorative lighting

	LED			90 CRI	40 IP	230 V	50/60 Hz	10 IK	850° 		
SELV	3SDCM		5Y WARRANTY 5% FAILURE RATE	60.000 h LED LIFETIME L90B10			19 UGR	On request		Only for cod. MP	

IT

Lampada da terra decorativa. Corpo ultrapiatto in estruso di alluminio calandrato. Sorgente luminosa LED diretta. Verniciatura con polveri epossidiche antigraffio. Diffusore in policarbonato opale (cod. OP), microprismatico UGR 19 (cod. MP). Alimentatore incorporato.

EN

Floor decorative lighting. Extruded calendered aluminum ultra-flat body. Direct LED light source. Painted with scratch-resistant epoxy powders. Opal polycarbonate diffuser (code OP), microprismatic UGR 19 (code MP). Built-in driver.

FR

Décoratif lampe au sol. Corps extra plat en aluminium extrudé courbé. Source lumineuse LED directe. Finition de peinture en poudre époxy anti-rayures. Diffuseur en polycarbonate opal (réf. OP), microprismé UGR 19 (réf. MP). Alimentation avec driver intégré.

ES

Luminaria de suelo decorativa. Cuerpo ultraplano de aluminio extruido calandrado. Fuente de iluminación LED directa. Barnizado con polvo epoxi anti-rayado. Difusor de policarbonato opal (código OP), microprismatico UGR19 (código MP). Balasto integrado.

DE

Dekoratives Stehleuchte. Ultraflacher Körper aus extrudiertem, kalandriertem Aluminium. Direkte LED-Lichtquelle. Lackiert mit kratzfesten Epoxidpulvern. Diffusor aus opalem Polycarbonat (Kode OP), mikroprismatisch UGR 19 (Kode MP) Integrierter Treiber.

SOO pd



SOO pd 4000 K

Code	Diffuser	Size	Lumen Out*	Watt Tot	K	Beam angle	Driver Type	Driver Nr.	Colour
YSPD20N	OP: Opal	01	5400	60	4000	D	ON/OFF	1	○
YSPD15N	MP: Microprismatic	01	2700	30	4000	D	ON/OFF	1	○

SOO pd 3000 K

Code	Diffuser	Size	Lumen Out*	Watt Tot	K	Beam angle	Driver Type	Driver Nr.	Colour
YSPD20W	OP: Opal	01	5100	60	3000	D	ON/OFF	1	○
YSPD15W	MP: Microprismatic	01	2550	30	3000	D	ON/OFF	1	○

*Output flux with opal diffuser. With microprismatic diffuser + 10%

SOO pd STANDARD COLOUR SELECTION

● **WI** | White Irazu ● **BLL** | Black Lava

SOO pd ON REQUEST COLOUR SELECTION

● **BF** | Beige Futuna ● **SB** | Silver Bombalai ● **GK** | Gold Karkar
 ● **BL** | Bronze Lario ● **RR** | Rust Rame ● **BT** | Blue Telica

SOO pd BEAM ANGLE | DIMENSIONS



Size	H [mm]	X [mm]	Y [mm]	Z [mm]	Kg
01	1962	10	410	50	15

Min and Max room temperature: -20°+45° C.

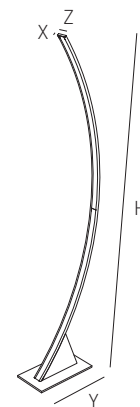





SOOO podi



SOO pdi



Floor decorative lighting

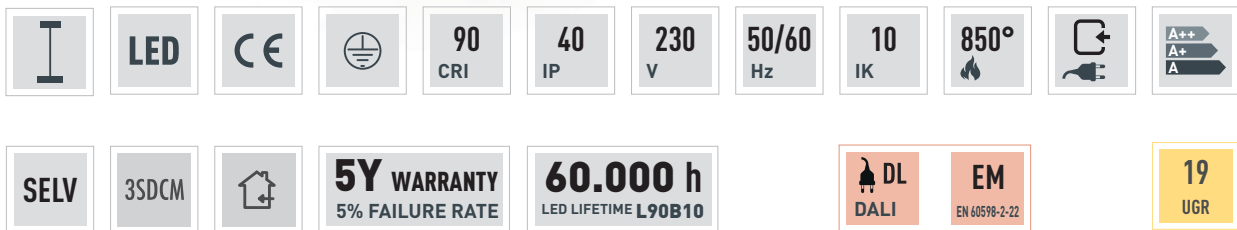

On request

Only for cod. MP

IT

Lampada da terra decorativa. Corpo ultrapiatto in estruso di alluminio calandrato. Sorgente luminosa LED indiretta. Verniciatura con polveri epossidiche antigraffio. Diffusore in policarbonato opale (cod. OP), microprismatico UGR 19 (cod. MP). Alimentatore incorporato.

EN

Floor decorative lighting. Extruded calendered aluminum ultra-flat body. Indirect LED light source. Painted with scratch-resistant epoxy powders. Opal polycarbonate diffuser (code OP), microprismatic UGR 19 (code MP). Built-in driver.

FR

Décoratif lampe au sol. Corps extra plat en aluminium extrudé courbé. Source lumineuse LED indirecte. Finition de peinture en poudre époxy anti-rayures. Diffuseur en polycarbonate opal (réf. OP), microprismé UGR 19 (réf. MP). Alimentation avec driver intégré.

ES

Luminaria de suelo decorativa. Cuerpo ultraplano de aluminio extruido calandrado. Fuente de iluminación LED indirecta. Barnizado con polvo epoxi anti-rayado. Difusor de policarbonato opal (código OP), microprismatico UGR19 (código MP). Balasto integrado.

DE

Dekoratives Stehleuchte. Ultraflacher Körper aus extrudiertem, kalandriertem Aluminium. Indirekte LED-Lichtquelle. Lackiert mit kratzfesten Epoxidpulvern. Diffusor aus opalem Polycarbonat (Kode OP), mikroprismatisch UGR 19 (Kode MP) Integrierter Treiber.

SOO pdi



SOO pdi 4000 K

Code	Diffuser	Size	Lumen Out*	Watt Tot	K	Beam angle	Driver Type	Driver Nr.	Colour
YSPDI20N	OP: Opal	01	5400+3400	100	4000	D	ON/OFF	1	○
YSPDI15N	MP: Microprismatic	01	2700+1700	50	4000	D	ON/OFF	1	○

SOO pdi 3000 K

Code	Diffuser	Size	Lumen Out*	Watt Tot	K	Beam angle	Driver Type	Driver Nr.	Colour
YSPDI20W	OP: Opal	01	5100+2550	100	3000	D	ON/OFF	1	○
YSPDI15W	MP: Microprismatic	01	2550+1560	50	3000	D	ON/OFF	1	○

*Output flux with opal diffuser. With microprismatic diffuser + 10%

SOO pdi STANDARD COLOUR SELECTION

● **WI** | White Irazu ● **BLL** | Black Lava

SOO pdi ON REQUEST COLOUR SELECTION

● **BF** | Beige Futuna ● **SB** | Silver Bombalai ● **GK** | Gold Karkar
 ● **BL** | Bronze Lario ● **RR** | Rust Rame ● **BT** | Blue Telica

SOO pdi BEAM ANGLE | DIMENSIONS



Size	H [mm]	X [mm]	Y [mm]	Z [mm]	Kg
01	1962	20	410	50	18

Min and Max room temperature: -20°+45° C.

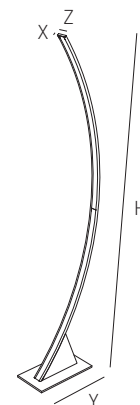





Armaaddeus



Amadeus



Floor decorative lighting

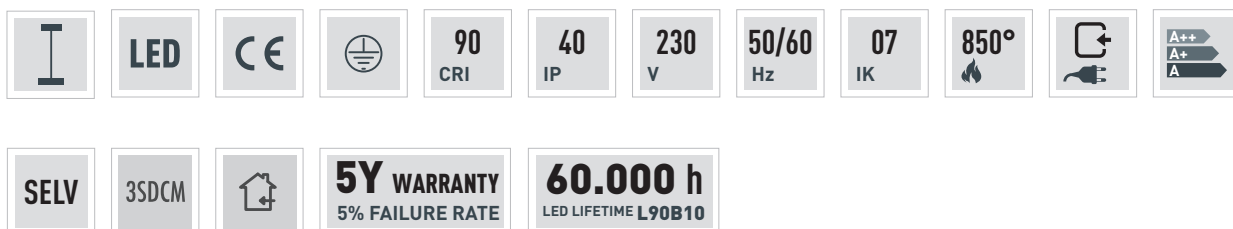

IT

Lampada da terra decorativa. Corpo in acciaio al carbonio pressopiegato. Sorgente luminosa LED multichip. Verniciatura con polveri epossidiche antigraffio. Schermo di chiusura in policarbonato opale. Alimentatore incorporato.

ES

Luminaria de suelo decorativa. Cuerpo de acero al carbono plegado. Fuente de iluminación LED multichip. Recubierta con polvo epoxi anti-rayado. Difusor de policarbonato opal. Balasto integrado.

EN

Floor decorative lighting. Bent carbon steel body. Multichip LED lighting source. Anti-scratch epoxy powder paint finish. Opal polycarbonate closing reflector. Built-in driver.

DE

Dekorative Stehleuchte. Körper aus pressgeformtem Kohlenstoffstahl. Multichip LED-Leuchtmittel. Lackierung mit kratzfesten Epoxypulvern. Abdeckschirm aus opalem Polycarbonat. Integrierter Treiber.

FR

Décoratif lampe au sol. Corps en acier au carbone courbé. Source de lumière en LED multichip. Finition de peinture en poudre époxy anti-rayures. Écran de fermeture en polycarbonate opale. Alimentation avec driver intégré.

Amadeus



AMADEUS 4000 K

Code	Size	Lumen Out	Watt Tot	K	Beam angle	Driver Type	Driver no.	Colour
YAM84N	01	5843	53	4000	D	ON/OFF	1	○

AMADEUS 3000 K

Code	Size	Lumen Out	Watt Tot	K	Beam angle	Driver Type	Driver no.	Colour
YAM84W	01	5410	53	3000	D	ON/OFF	1	○

AMADEUS STANDARD COLOUR SELECTION

● **WI** | White Irazu

● **BLL** | Black Lava

AMADEUS ON REQUEST COLOUR SELECTION

● **BF** | Beige Futuna

● **SB** | Silver Bombalai

● **GK** | Gold Karkar

● **BL** | Bronze Lario

● **RR** | Rust Rame

● **BT** | Blue Telica

AMADEUS BEAM ANGLE | DIMENSIONS

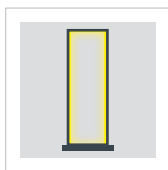

Size	X (mm)	Y (mm)	Z (mm)	K (mm)	Kg
01	∅ 320	340	1670	27	15,0

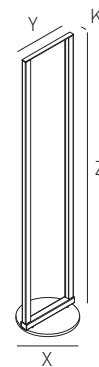

Min and Max room temperature: -20°+45° C.





Silence



Silence



Floor decorative lighting

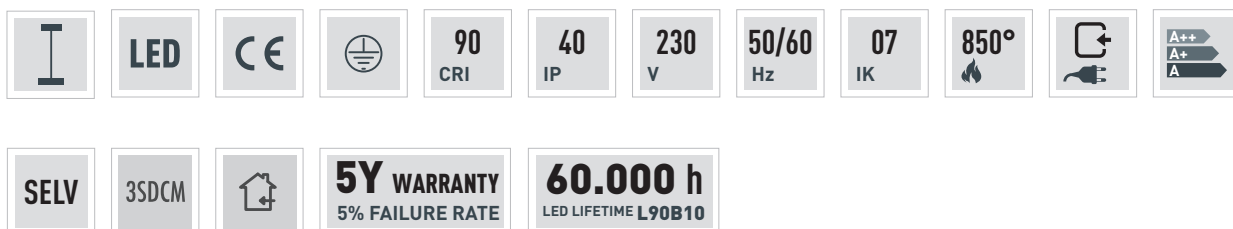

IT

Lampada da terra decorativa. Corpo in acciaio al carbonio pressopiegato. Sorgente luminosa LED multichip. Verniciatura con polveri epossidiche antigraffio. Schermo di chiusura in policarbonato opale. Alimentatore incorporato.

ES

Luminaria de suelo decorativa. Cuerpo de acero al carbono plegado. Fuente de iluminación LED multichip. Recubierta con polvo epoxi anti-rayado. Difusor de policarbonato opal. Balasto integrado.

EN

Floor decorative lighting. Bent carbon steel body. Multichip LED lighting source. Anti-scratch epoxy powder paint finish. Opal polycarbonate closing reflector. Built-in driver.

DE

Dekoratives Stehleuchte. Körper aus pressgeformtem Kohlenstoffstahl. Multichip LED-Leuchtmittel. Lackierung mit kratzfesten Epoxypulvern. Abdeckschirm aus opalem Polycarbonat. Integrierter Treiber.

FR

Décoratif lampe au sol. Corps en acier au carbone courbé. Source de lumière en LED multichip. Finition de peinture en poudre époxy anti-rayures. Écran de fermeture en polycarbonate opale. Alimentation avec driver intégré.

Silence



SILENCE 4000 K

Code	Size	Lumen Out	Watt Tot	K	Beam angle	Driver Type	Driver no.	Colour
YSI34N	01	4298	39	4000	D	ON/OFF	1	○

SILENCE 3000 K

Code	Size	Lumen Out	Watt Tot	K	Beam angle	Driver Type	Driver no.	Colour
YSI34W	01	3980	39	3000	D	ON/OFF	1	○

SILENCE STANDARD COLOUR SELECTION

- WI** | White Irazu
- BLL** | Black Lava

SILENCE ON REQUEST COLOUR SELECTION

- BF** | Beige Futuna
- SB** | Silver Bombalai
- GK** | Gold Karkar
- BL** | Bronze Lario
- RR** | Rust Rame
- BT** | Blue Telica

SILENCE BEAM ANGLE | DIMENSIONS



Size	X (mm)	Y (mm)	Z (mm)	K (mm)	J (mm)	Kg
01	340	254	1632	27	300	10,0

Min and Max room temperature: -20°+45° C.

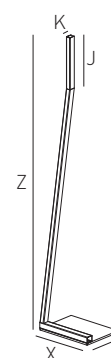





Utile



Utile

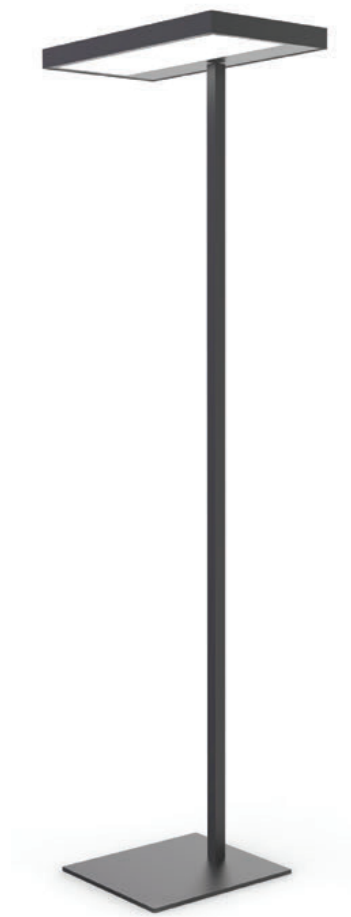

Floor decorative lighting

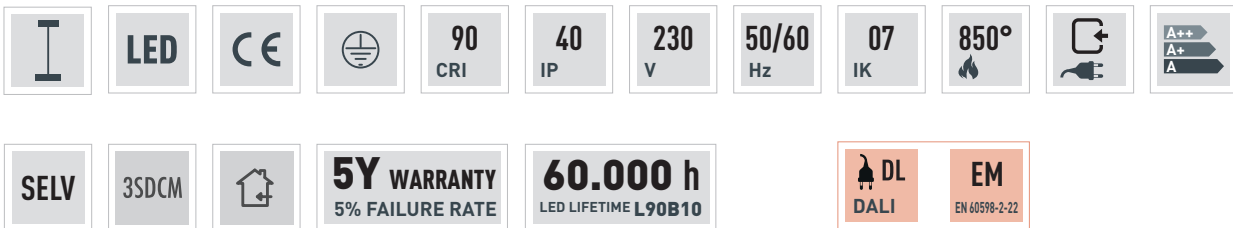

On request

IT

Lampada da terra decorativa. Corpo in alluminio estruso. Struttura di supporto in acciaio al carbonio. Sorgente luminosa LED multichip. Verniciatura con polveri epossidiche antigraffio. Schermo di chiusura in policarbonato opale. Alimentatore incorporato.

EN

Floor decorative lighting. Extruded aluminium body. Support structure in carbon steel. Multichip LED lighting source. Anti-scratch epoxy powder paint finish. Opal polycarbonate closing reflector. Built-in driver.

FR

Décoratif lampe au sol. Corps en aluminium extrudé. Structure de support en acier au carbone. Source de lumière en LED multichip. Finition de peinture en poudre époxy anti-rayures. Écran de fermeture en polycarbonate opale. Alimentation avec driver intégré.

ES

Luminaria de suelo decorativa. Cuerpo en aluminio extruido. Estructura de Estructura de soporte en acero al carbono. Fuente de iluminación LED multichip. Recubierta con polvo epoxi anti-rayado. Difusor de policarbonato opal. Balasto integrado.

DE

Dekoratives Stehleuchte. Körper aus extrudiertem Aluminium. Tragstruktur aus Kohlenstoffstahl. Multichip LEDLeuchtmittel. Lackierung mit kratzfesten Epoxypulvern. Abdeckschirm aus opalem Polycarbonat. Integrierter Treiber.



UTILE 4000 K

Code	Size	Lumen Out	Watt Tot	K	Beam angle	Driver Type	Driver no.	Colour
EMISSIONE INDIRETTA (I)								
YUTI48N	01	4760	43	4000	D	ON/OFF	1	○

Code	Size	Lumen Out	Watt Tot	K	Beam angle	Driver Type	Driver no.	Colour
EMISSIONE DIRETTA + INDIRETTA (D+I)								
YUTDI72N	01	9525	86	4000	D	ON/OFF	1	○

UTILE 3000 K

Code	Size	Lumen Out	Watt Tot	K	Beam angle	Driver Type	Driver no.	Colour
EMISSIONE INDIRETTA (I)								
YUTI48W	01	4410	43	3000	D	ON/OFF	1	○

Code	Size	Lumen Out	Watt Tot	K	Beam angle	Driver Type	Driver no.	Colour
EMISSIONE DIRETTA + INDIRETTA (D+I)								
YUTDI72W	01	8820	86	3000	D	ON/OFF	1	○

UTILE STANDARD COLOUR SELECTION

- **WI** | White Irazu
- **BLL** | Black Lava

UTILE ON REQUEST COLOUR SELECTION

- **BF** | Beige Futuna
- **SB** | Silver Bombalai
- **GK** | Gold Karkar
- **BL** | Bronze Lario
- **RR** | Rust Rame
- **BT** | Blue Telica

UTILE BEAM ANGLE | DIMENSIONS

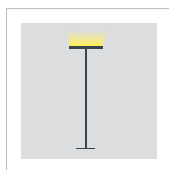

I

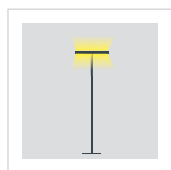

D+I

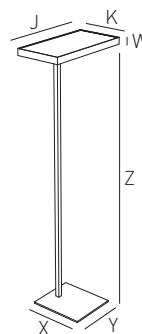

Min and Max room temperature: -20°+45° C.

Size	X (mm)	Y (mm)	Z (mm)	J (mm)	K (mm)	W (mm)	Kg
01	400	355	1910	620	260	45	16,0





Zero



Zero

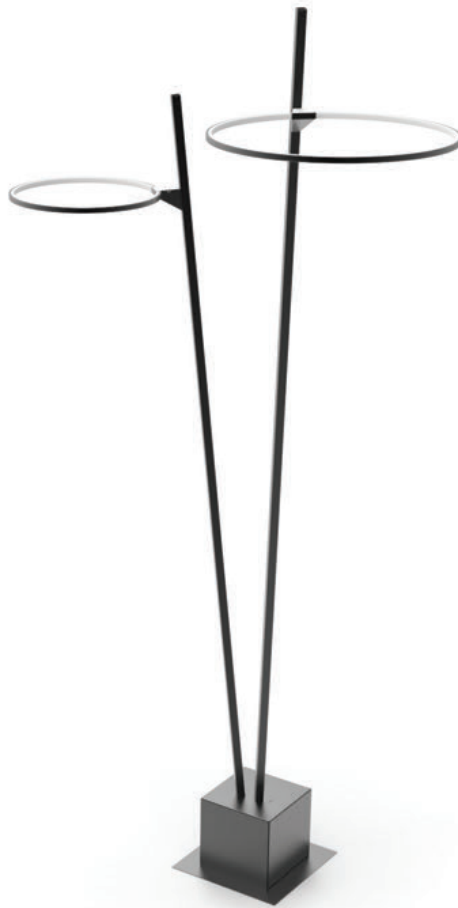

Floor decorative lighting

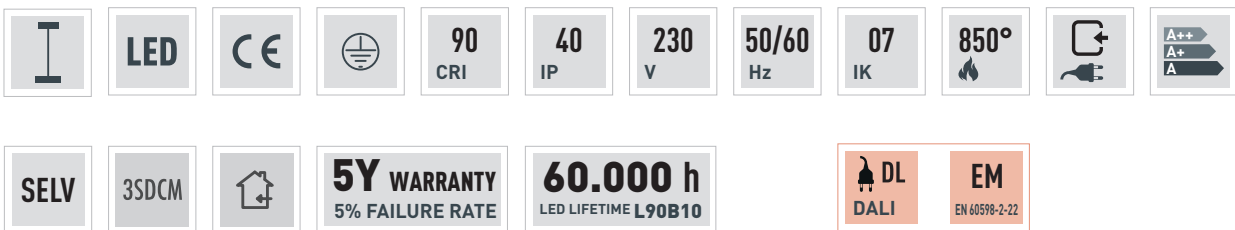

On request

IT

Lampada da terra decorativa. Corpo in alluminio estruso calandrato. Struttura di supporto in acciaio al carbonio. Sorgente luminosa LED multichip. Verniciatura con polveri epossidiche antigraffio. Schermo di chiusura in silicone opale. Alimentatore incorporato.

ES

Luminaria de suelo decorativa. Cuerpo de aluminio torneado y calandrado. Estructura de soporte en acero al carbono. Fuente de iluminación LED multichip. Recubierta con polvo epoxi anti-rayado. Difusor de silicona opal. Balasto integrado.

EN

Floor for decorative lighting. Extruded and calendered aluminum body. Support structure in carbon steel. Multichip LED lighting source. Anti-scratch epoxy powder paint finish. Opal silicone closing reflector. Built-in driver.

DE

Dekoratives Stehleuchte. Extrudierter aus kalandrierter Aluminiumkörper. Tragstruktur aus Kohlenstoffstahl. Multichip LED-Leuchtmittel. Lackierung mit kratzfesten Epoxypulvern. Opalabdeckschirm aus Silikon. Integrierter Treiber.

FR

Décoratif lampe au sol. Corps en aluminium extrudé et calandré. Structure de support en acier au carbone. Source de lumière en LED multichip. Finition de peinture en poudre époxy anti-rayures. Écran de fermeture en silicone opale. Alimentation avec driver intégré.

Zero

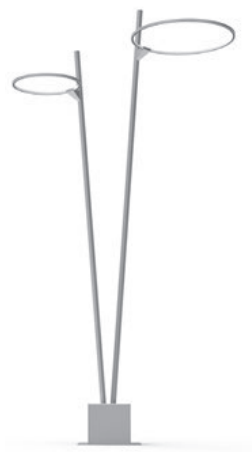

ZERO 4000 K

Code	Size	Lumen Out	Watt Tot	K	Beam angle	Driver Type	Driver no.	Colour
YZE66N	01	6935	65	4000	D	ON/OFF	1	○

ZERO 3000 K

Code	Size	Lumen Out	Watt Tot	K	Beam angle	Driver Type	Driver no.	Colour
YZE66W	01	6421	65	3000	D	ON/OFF	1	○

ZERO STANDARD COLOUR SELECTION

- **WI** | White Irazu
- **BLL** | Black Lava

ZERO ON REQUEST COLOUR SELECTION

- **BF** | Beige Futuna
- **SB** | Silver Bombalai
- **GK** | Gold Karkar
- **BL** | Bronze Lario
- **RR** | Rust Rame
- **BT** | Blue Telica

ZERO BEAM ANGLE | DIMENSIONS

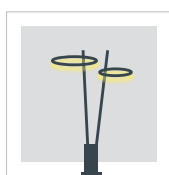

Size	X [mm]	Y [mm]	J [mm]	Z [mm]	K [mm]	W [mm]	Kg
01	300	300	200	2100	1900	*	15,0

* W [mm]:



1= ø 325



2= ø 485

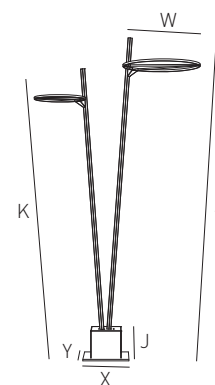

Min and Max room temperature: -20°+45° C.





Furboa



Furba



Floor decorative lighting

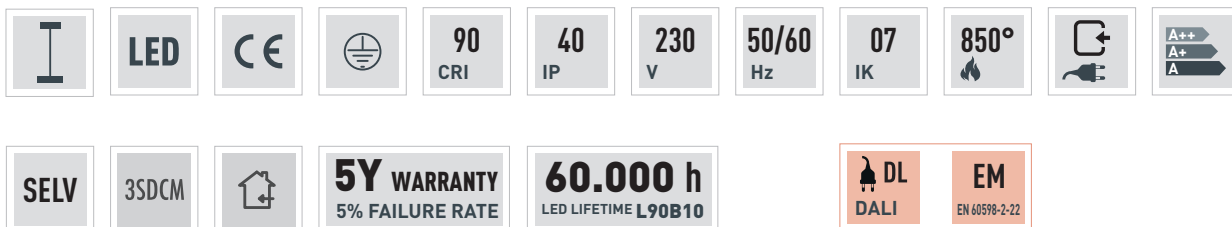

On request

IT

Lampada da terra decorativa. Vano alimentatore in alluminio estruso. Verniciatura con polveri epossidiche antigraffio. Corpo diffusore in policarbonato opale. Sorgente luminosa LED multichip. Alimentatore incorporato.

EN

Floor decorative lighting. Extruded aluminium power supply compartment. Anti-scratch epoxy powder paint finish. Opal polycarbonate diffuser body. Multichip LED lighting source. Built-in driver.

FR

Décoratif lampe au sol. Compartiment d'alimentation en aluminium extrudé. Finition de peinture en poudre époxy anti-rayures. Corps diffuseur en polycarbonate opale. LED multichip. Corps diffuseur en polycarbonate opale. Alimentation avec driver intégré.

ES

Luminaria de suelo decorativa. Compartimento de fuente de alimentación en aluminio extruido. Finition de peinture en poudre époxy anti-rayures. Cuerpo difusor de policarbonato opal. Fuente de iluminación LED multichip. Balasto integrado.

DE

Dekoratives Stehleuchte. Netzteilfach aus extrudiertem Aluminium. Lackierung mit kratzfesten Epoxypulvern. Diffusor Körper aus opalem Polycarbonat. Multichip LED-Leuchtmittel. Integrierter Treiber.

Furba

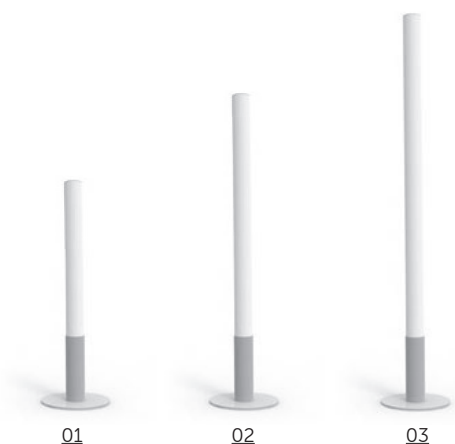

FURBA 4000 K

Code	Size	Lumen Out	Watt Tot	K	Beam angle	Driver Type	Driver no.	Colour
YFU13N	01	5303	46	4000	D	ON/OFF	1	○
YFU18N	02	7954	69	4000	D	ON/OFF	1	○
YFU23N	03	10606	92	4000	D	ON/OFF	1	○

FURBA 3000 K

Code	Size	Lumen Out	Watt Tot	K	Beam angle	Driver Type	Driver no.	Colour
YFU13W	01	4910	46	3000	D	ON/OFF	1	○
YFU18W	02	7365	69	3000	D	ON/OFF	1	○
YFU23W	03	9820	92	3000	D	ON/OFF	1	○

FURBA STANDARD COLOUR SELECTION

● **WI** | White Irazu ● **BLL** | Black Lava

FURBA ON REQUEST COLOUR SELECTION

● **BF** | Beige Futuna ● **SB** | Silver Bombalai ● **GK** | Gold Karkar
 ● **BL** | Bronze Lario ● **RR** | Rust Rame ● **BT** | Blue Telica

FURBA BEAM ANGLE | DIMENSIONS

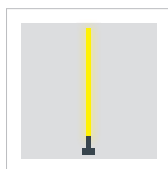

Size	X [mm]	Y [mm]	Z [mm]	K [mm]	J [mm]	Kg
01	Ø 320	Ø 83	1360	1000	350	14,2
02	Ø 320	Ø 83	1860	1500	350	15,5
03	Ø 320	Ø 83	2360	2000	350	17,2

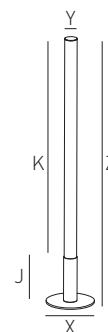

Min and Max room temperature: -20°+45° C.



Table Lamp





S O O C



SOO c



Table Lamp

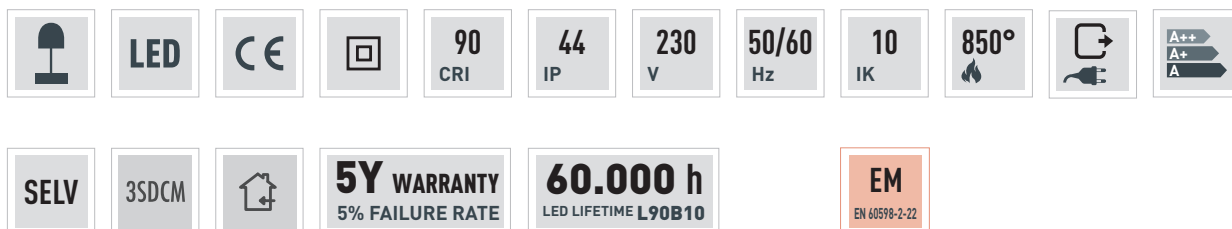

On request

IT

Lampada da tavolo decorativa. Corpo ultrapiatto in estruso di alluminio calandrato. Sorgente luminosa LED interna. Verniciatura con polveri epossidiche antigraffio. Diffusore in policarbonato opale (cod. OP), microprismatico UGR 19 (cod. MP). Alimentatore incluso esterno.

ES

Luminaria de mesa decorativa. Cuerpo ultraplano de aluminio extruido calandrado. Fuente de iluminación LED interna. Barnizado con polvo epoxi anti-rayado. Difusor de policarbonato opal (código OP), microprismatico UGR19 (código MP). Balasto externo incluido.

EN

Decorative table lamp. Extruded calendered aluminum ultra-flat body. Internal LED light source. Painted with scratch-resistant epoxy powders. Opal polycarbonate diffuser (code OP), microprismatic UGR 19 (code MP). External driver included.

DE

Dekorative Tischlampe. Ultraflacher Körper aus extrudiertem, kalandriertem Aluminium. Interne LED-Lichtquelle. Lackiert mit kratzfesten Epoxidpulvern. Diffusor aus opalem Polycarbonat (Kode OP), mikroprismatisch UGR 19 (Kode MP). Externer elektronischer Treiber enthalten.

FR

Lampe de table decorative. Corps extra plat en aluminium extrudé courbé. Source lumineuse LED interne. Finition de peinture en poudre époxy anti-rayures. Diffuseur en polycarbonate opale (réf. OP), microprismé UGR 19 (réf. MP). Driver externe inclus

S00 c

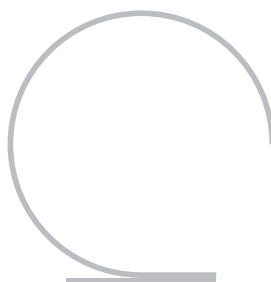

S00 c 4000 K

Code	Diffuser	Size	Lumen Out*	Watt Tot	K	Beam angle	Driver Type	Driver Nr.	Colour
YSCT40N	OP: Opal	01	1500	16,5	4000	D	ON/OFF	1	○

S00 c 3000 K

Code	Diffuser	Size	Lumen Out*	Watt Tot	K	Beam angle	Driver Type	Driver Nr.	Colour
YSCT40W	OP: Opal	01	1380	16,5	3000	D	ON/OFF	1	○

S00 c STANDARD COLOUR SELECTION

● **WI** | White Irazu ● **BLL** | Black Lava

S00 c ON REQUEST COLOUR SELECTION

● **BF** | Beige Futuna ● **SB** | Silver Bombalai ● **GK** | Gold Karkar
 ● **BL** | Bronze Lario ● **RR** | Rust Rame ● **BT** | Blue Telica

S00 c BEAM ANGLE | DIMENSIONS

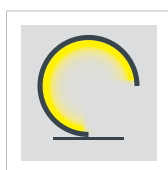

Size	X [mm]	Z [mm] ø	Kg
01	ø 400	50	4

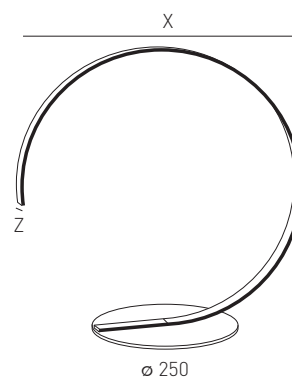

Min and Max room temperature: -20°+45° C.





SOOT



SOO t



Table Lamp

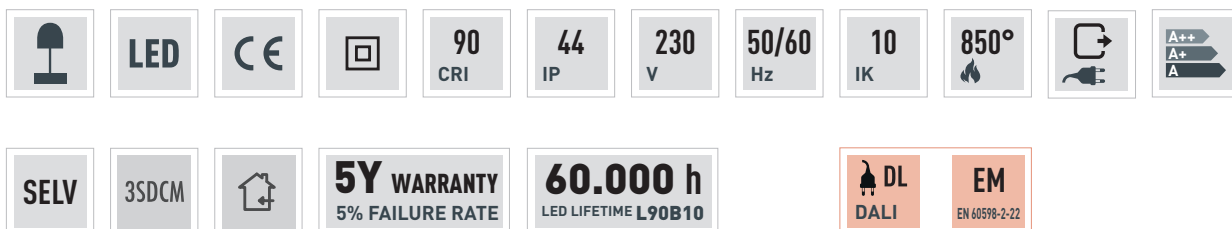

On request

IT

Lampada da tavolo decorativa. Corpo ultrapiatto in estruso di alluminio calandrato. Sorgente luminosa LED interna. Verniciatura con polveri epossidiche antigraffio. Diffusore in policarbonato opale (cod. OP), microprismato UGR 19 (cod. MP). Alimentatore incluso esterno.

ES

Luminaria de mesa decorativa. Cuerpo ultraplano de aluminio extruido calandrado. Fuente de iluminación LED interno. Barnizado con polvo epoxi anti-rayado. Difusor de policarbonato opal (código OP), microprismato UGR19 (código MP). Balasto externo incluido.

EN

Decorative table lamp. Extruded calendered aluminum ultra-flat body. Internal LED light source. Painted with scratch-resistant epoxy powders. Opal polycarbonate diffuser (code OP), microprismatic UGR 19 (code MP). External driver included.

DE

Dekorative Tischlampe. Ultraflacher Körper aus extrudiertem, kalandriertem Aluminium. Interne LED-Lichtquelle. Lackiert mit kratzfesten Epoxidpulvern. Diffusor aus opalem Polycarbonat (Kode OP), mikroprismatisch UGR 19 (Kode MP). Externer elektronischer Treiber enthalten.

FR

Lampe de table decorative. Corps extra plat en aluminium extrudé courbé. Source lumineuse LED interne. Finition de peinture en poudre époxy anti-rayures. Diffuseur en polycarbonate opale (réf. OP), microprismé UGR 19 (réf. MP). Driver externe inclus

SOO t

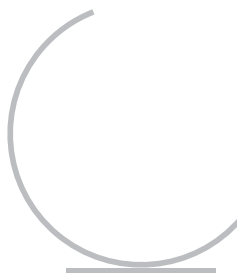

SOO t 4000 K

Code	Diffuser	Size	Lumen Out*	Watt Tot	K	Beam angle	Driver Type	Driver Nr.	Colour
YST40N	OP: Opal	01	1400	16,5	4000	D	ON/OFF	1	○

SOO t 3000 K

Code	Diffuser	Size	Lumen Out*	Watt Tot	K	Beam angle	Driver Type	Driver Nr.	Colour
YST40W	OP: Opal	01	1290	16,5	3000	D	ON/OFF	1	○

SOO t STANDARD COLOUR SELECTION

● **WI** | White Irazu ● **BLL** | Black Lava

SOO t ON REQUEST COLOUR SELECTION

● **BF** | Beige Futuna ● **SB** | Silver Bombalai ● **GK** | Gold Karkar
 ● **BL** | Bronze Lario ● **RR** | Rust Rame ● **BT** | Blue Telica

SOO t BEAM ANGLE | DIMENSIONS

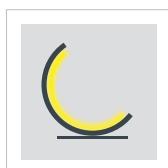

Size	X [mm]	Y [mm]	Z [mm]	Kg
01	400	400	50	3,5

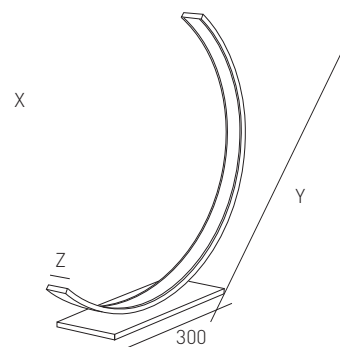

Min and Max room temperature: -20°+45° C.





Lina



Lina



Table Lamp

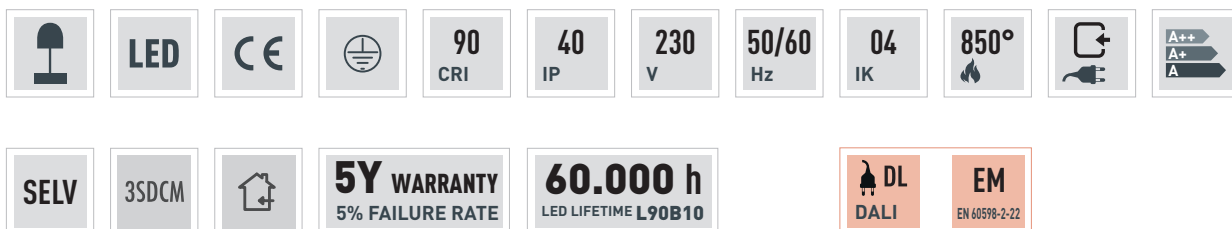

On request

IT

Lampada da tavolo decorativa. Base d'appoggio in acciaio al carbonio pressopiegato. Corpo lampada in alluminio estruso calandrato. Sorgente luminosa LED multichip. Verniciatura con polveri epossidiche antigraffio. Schermo di chiusura in silicone opale. Alimentatore incorporato.

ES

Luminaria de mesa decorativa. Base de apoyo en acero al carbono plegado a presión. Cuerpo en aluminio extruido y calandrado. Fuente de iluminación LED multichip. Barnizado con polvo epoxi anti-rayado. Difusor de silicona opal. Balasto integrado.

EN

Decorative table lamp. Bent carbon steel base support. Calendered extruded aluminum body. Multichip LED lighting source. Painted with scratch-resistant epoxy powders. Opal silicon closing reflector. Integrated driver.

DE

Dekorative Tischlampe. Stützbasis aus pressgeformtem Kohlenstoffstahl. Lampenkörper aus kalandriertem und Multichip LEDLeuchtmittel. Lackiert mit kratzfesten Epoxidpulvern. Abdeckschirm aus opal Silikon. Integrierter Treiber.

FR

Lampe de table decorative. Base de support en acier au carbone courbé. Corps de lampe en aluminium extrudé et calandré. Source de lumière en LED multichip. Finition de peinture en poudre époxy anti-rayures. Écran de fermeture en silicone opale. Alimentation avec driver intégré.



LINA 4000 K

Code	Size	Lumen Out	Watt Tot	K	Beam angle	Driver Type	Driver Nr.	Colour
YLI16N	01	1050	10	4000	D	ON/OFF	1	○

LINA 3000 K

Code	Size	Lumen Out	Watt Tot	K	Beam angle	Driver Type	Driver Nr.	Colour
YLI16W	01	972	10	3000	D	ON/OFF	1	○

LINA STANDARD COLOUR SELECTION

● **WI** | White Irazu ● **BLL** | Black Lava

LINA ON REQUEST COLOUR SELECTION

● **BF** | Beige Futuna ● **SB** | Silver Bombalai ● **GK** | Gold Karkar
 ● **BL** | Bronze Lario ● **RR** | Rust Rame ● **BT** | Blue Telica

LINA BEAM ANGLE | DIMENSIONS

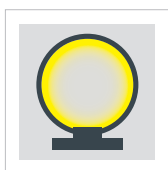

Size	X [mm]	Y [mm]	Z [∅]	Kg
01	130	130	∅ 165	1,2

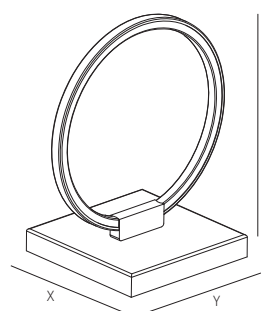

Min and Max room temperature: -20°+45° C.





Sphnere



Sphere



Table Lamp

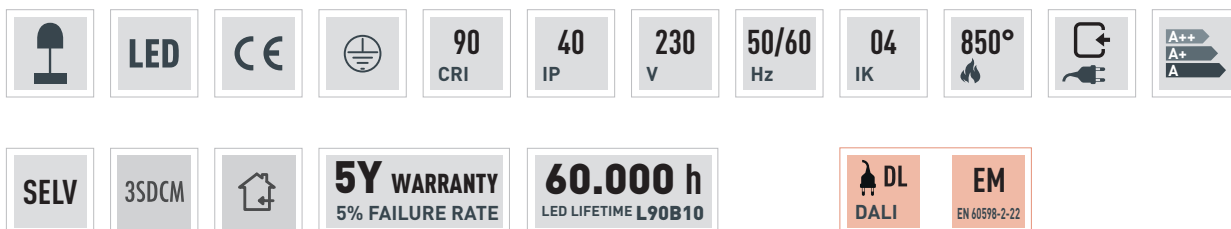

On request

IT

Lampada da tavolo decorativa.
Base d'appoggio in acciaio al carbonio pressopiegato. Corpo diffusore in policarbonato opale. Sorgente luminosa LED multichip. Verniciatura con polveri epossidiche antigraffio. Alimentatore incorporato.

EN

Decorative table lamp. Bent carbon steel base support. Opal polycarbonate body diffuser. Multichip LED lighting source. Painted with scratch-resistant epoxy powders. Integrated driver.

FR

Lampe de table decorative.
Base de support en acier au carbone courbé. Corps diffuseur en polycarbonate opale. Source de lumière en LED multichip. Finition de peinture en poudre époxy anti-rayures. Alimentation avec driver intégré.

ES

Luminaria de mesa decorativa.
Base de apoyo en acero al carbono plegado a presión. Cuerpo difusor de policarbonato opal. Fuente de iluminación LED multichip. Barnizado con polvo epoxi anti-rayado. Balasto integrado.

DE

Dekorative Tischlampe. Stützbasis aus pressgeformtem Kohlenstoffstahl. Diffusor Körper aus opalem Polycarbonat. Multichip LEDLeuchtmittel. Lackiert mit kratzfesten Epoxidpulvern. Integrierter Treiber.

Sphere



SPHERE 4000 K

Code	Size	Lumen	Watt	K	Beam angle	Driver Type	Driver Nr.	Colour
YSP15N	01	816	10	4000	D	ON/OFF	1	○

SPHERE 3000 K

Code	Size	Lumen	Watt	K	Beam angle	Driver Type	Driver Nr.	Colour
YSP15W	01	756	10	3000	D	ON/OFF	1	○

SPHERE STANDARD COLOUR SELECTION

● **WI** | White Irazu ● **BLL** | Black Lava

SPHERE ON REQUEST COLOUR SELECTION

● **BF** | Beige Futuna ● **SB** | Silver Bombalai ● **GK** | Gold Karkar
 ● **BL** | Bronze Lario ● **RR** | Rust Rame ● **BT** | Blue Telica

SPHERE BEAM ANGLE | DIMENSIONS

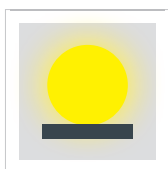

Size	X (mm)	Y (mm)	Z (mm)	Ø	Kg
01	150	150	25	Ø 150	1,2

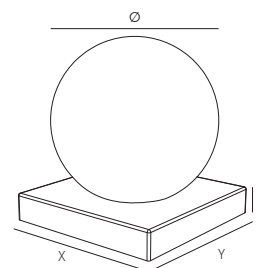

Min and Max room temperature: -20°+45° C.





Squadra



Squadra



Table Lamp



On request

IT

Lampada da tavolo decorativa. Base d'appoggio e corpo lampada in acciaio al carbonio pressopiegato. Sorgente luminosa LED multichip. Verniciatura con polveri epossidiche antigraffio. Schermo di chiusura in policarbonato opale. Alimentatore incorporato.

ES

Luminaria de mesa decorativa. Base de apoyo y cuerpo en acero al carbono plegado a presión. Source de lumière en LED multichip. Finition de peinture en poudre époxy anti-rayures. Écran de fermeture en polycarbonate opale. Alimentation avec driver intégré.

EN

Decorative table lamp. Bent carbon steel base support and body. Multichip LED lighting source. Painted with scratch-resistant epoxy powders. Opal polycarbonate closing reflector. Integrated driver.

DE

Dekorative Tischlampe. Stützbasis und Lampenkörper aus pressgeformtem Kohlenstoffstahl. Multichip LEDLeuchtmittel. Lackiert mit kratzfesten Epoxidpulvern. Abdeckschirm aus opal Polycarbonat. Integrierter Treiber.

FR

Lampe de table decorative. Base de support et corps en acier au carbone courbé. Source de lumière en LED multichip. Finition de peinture en poudre époxy anti-rayures. Écran de fermeture en polycarbonate opale. Alimentation avec driver intégré.

Squadra



SQUADRA 4000 K

Code	Size	Lumen Out	Watt Tot	K	Beam angle	Driver Type	Driver Nr.	Colour
YSQ43N	01	816	10	4000	D	ON/OFF	1	○

SQUADRA 3000 K

Code	Size	Lumen Out	Watt Tot	K	Beam angle	Driver Type	Driver Nr.	Colour
YSQ43W	01	756	10	3000	D	ON/OFF	1	○

SQUADRA STANDARD COLOUR SELECTION

● **WI** | White Irazu ● **BLL** | Black Lava

SQUADRA ON REQUEST COLOUR SELECTION

● **BF** | Beige Futuna ● **SB** | Silver Bombalai ● **GK** | Gold Karkar
 ● **BL** | Bronze Lario ● **RR** | Rust Rame ● **BT** | Blue Telica

SQUADRA BEAM ANGLE | DIMENSIONS

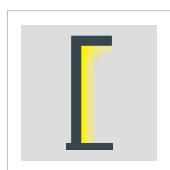

Size	X [mm]	Y [mm]	Z [mm]	Kg
01	150	150	430	1,6

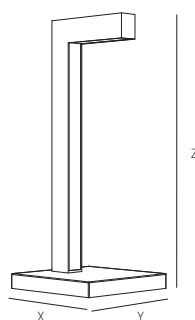

Min and Max room temperature: -20°+45° C.





Stilo



Stilo



Table Lamp



On request

IT

Lampada da tavolo decorativa. Base d'appoggio e corpo lampada in acciaio al carbonio pressopiegato. Sorgente luminosa LED multichip. Verniciatura con polveri epossidiche antigraffio. Schermo di chiusura in policarbonato opale. Alimentatore incorporato.

ES

Luminaria de mesa decorativa. Base de apoyo y cuerpo en acero al carbono plegado a presión. Source de lumière en LED multichip. Finition de peinture en poudre époxy anti-rayures. Écran de fermeture en polycarbonate opale. Alimentation avec driver intégré.

EN

Decorative table lamp. Bent carbon steel base support and body. Multichip LED lighting source. Painted with scratch-resistant epoxy powders. Opal polycarbonate closing reflector. Integrated driver.

DE

Dekorative Tischlampe. Stützbasis und Lampenkörper aus pressgeformtem Kohlenstoffstahl. Multichip LEDLeuchtmittel. Lackiert mit kratzfesten Epoxidpulvern. Abdeckschirm aus opal Polycarbonat. Integrierter Treiber.

FR

Lampe de table decorative. Base de support et corps en acier au carbone courbé. Source de lumière en LED multichip. Finition de peinture en poudre époxy anti-rayures. Écran de fermeture en polycarbonate opale. Alimentation avec driver intégré.



STILO 4000 K

Code	Size	Lumen Out	Watt Tot	K	Beam angle	Driver Type	Driver Nr.	Colour
YST32N	01	816	10	4000	D	ON/OFF	1	○

STILO 4000 K

Code	Size	Lumen Out	Watt Tot	K	Beam angle	Driver Type	Driver Nr.	Colour
YST32W	01	756	10	3000	D	ON/OFF	1	○

STILO STANDARD COLOUR SELECTION

- **WI** | White Irazu
- **BLL** | Black Lava

STILO ON REQUEST COLOUR SELECTION

- **BF** | Beige Futuna
- **SB** | Silver Bombalai
- **GK** | Gold Karkar
- **BL** | Bronze Lario
- **RR** | Rust Rame
- **BT** | Blue Telica

STILO BEAM ANGLE | DIMENSIONS



Size	X [mm]	Y [mm]	Z [mm]	Kg
01	150	150	320	1,2

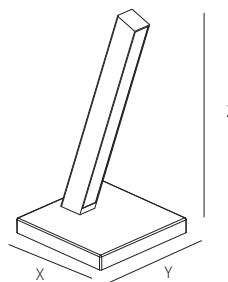

Min and Max room temperature: -20°+45° C.

LEGENDA

HOW TO READ THE CATALOGUE

Arrondo d ¹



Decorative suspension lighting fitting

LED **CE** **90 CRI** **40 IP** **230 V** **50/60 Hz** **07 IK** **850°**

SELV **350CM** **5Y WARRANTY** **60.000 h** **DALI** **EM** **19 USB**

IT
Apparecchio decorativo per installazione a sospensione o plafone con accessorio fiamme separatamente. Corpo in acciaio al carbonio calandrato e pressopiegato. Sorgente luminosa LED multichip diretta. Vercatura con polveri epossidiche antigraffio. Schema di chiusura in policarbonato microprismatico UGR 19 (cod. MP). Opale local. OP. Alimentatore incorporato. Rosette per collegamento elettrico non inclusa, da ordinare separatamente.

EN
Decorative suspension or ceiling lighting fitting, mounting accessory to be ordered separately. Bent and calandrated carbon steel body. Direct multichip LED light source. Painted with scratch-resistant epoxy powders. Opal polycarbonate diffuser (code MP). Microprismatic UGR 19 (code MP). Built-in driver. Rise ceiling for electrical connection not included, to be ordered separately.

DE
Luminaire dekorativ de suspension o de techo con accesorio suministrado por separado. Cuerpo de acero al carbono laminado y calandrado. Fuente de luminancia LED directa. Barnizado con polvo epoxi anti-rayado. Difusor de policarbonato opal (codigo MP). Balasto integrado. Roseta electrificadna no incluida, a pedir por separado.

FR
Luminaire décoratif pour installation en suspension, ou plafonné avec accessoire fourni séparément. Corps en acier au carbone plié à la presse et calandré. Source lumineuse LED multichip directe. Finition de peinture en poudre époxy anti-rayure. Diffusur en polycarbonate opal (ref. OP). microprisme UGR 19 (ref. MP). Alimentation avec driver intégré. Patère et branchement électrique exclus, à commander séparément.

1 Arrondo d



Code	Difusor	Size	Lumen Out*	Watt Tot	K	Beam angle	Driver Type	Driver Nr.	Colour
YAR10N	OP	01	8350	83	4000	D	ON/OFF	1	○
YAR12N	Dist	02	10520	107	4000	D	ON/OFF	1	○
YAR15N	MP	03	13700	139	4000	D	ON/OFF	1	○
YAR20N	MP	04	18225	181	4000	D	ON/OFF	1	○
YAR30N	MP	05	27335	271	4000	D	ON/OFF	1	○

5 ARRONDO d 3000 K

Code	Difusor	Size	Lumen Out*	Watt Tot	K	Beam angle	Driver Type	Driver Nr.	Colour
YAR10W	OP	01	7735	83	3000	D	ON/OFF	1	○
YAR12W	Dist	02	9740	107	3000	D	ON/OFF	1	○
YAR15W	MP	03	12685	139	3000	D	ON/OFF	1	○
YAR20W	MP	04	16875	181	3000	D	ON/OFF	1	○
YAR30W	MP	05	25310	271	3000	D	ON/OFF	1	○

*Output flux with opal diffuser. With microprismatic diffuser + 10%.

6 ARRONDO d STANDARD COLOUR SELECTION

- WH | White Izu
- BL | Black Lava

6 ARRONDO d ON REQUEST COLOUR SELECTION

- BF | Beige Futura
- SB | Silver Bombala
- GR | Gold Karkar
- BR | Bronze Lario
- RR | Rust Ramè
- BT | Blue Telica

7 ARRONDO d BEAM ANGLE | DIMENSIONS

Size	X (mm)	Y (mm)	Z (mm)	Kg
01	1000	100	80	11.0
02	1200	100	80	13.0
03	1500	100	80	16.5
04	2000	100	80	26.0
05	3000	100	100	39.0

Min and Max room temperature: -20° +45° C.

8 ARRONDO ACCESSORIES

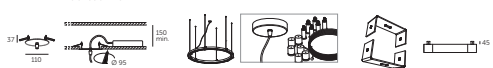

- KT10301 - COLOUR: Rose ceiling for installation with ceiling panel.
- YKT35 - COLOUR (size 01-02): 3 suspension cables, length: 2 m*
- YKT45 - COLOUR (size 03-04): 4 suspension cables, length: 2 m*
- YKT65 - COLOUR (size 05): 6 suspension cables, length: 2 m*
- YKTP35 - COLOUR (size 01-02): 3 brackets for ceiling installation (H45 mm)
- YKTP45 - COLOUR (size 03-04): 4 brackets for ceiling installation (H45 mm)
- YKTP65 - COLOUR (size 05): 6 brackets for ceiling installation (H45 mm)

*Rose ceiling for brick installation Ø 120 mm H25 mm

	EN	IT	FR	ES	DE
1	Fitting name	Denominazione articolo	Désignation de l'article	Designación del artículo	Artikelbezeichnung
2	Product image	Immagine prodotto	Image du produit	Imagen del Producto	Produktbild
3	Technical details (See symbols Page 22-25)	Dati tecnici (Vedi simboli Pag. 22-25)	Caractéristiques Techniques (Voir symboles Page 22-25)	Datos técnicos (Ver símbolos Página 22-25)	Technische Daten (siehe Symbole Seite 22-25)
4	Product description	Descrizione Prodotto	Description du produit	Descripción del producto	Produkt-Beschreibung
5	Product data (See page 21)	Dati prodotto (Vedi pagina 21)	Fiche produit (Voir page 21)	Datos del producto (Ver página 21)	Produktdaten (siehe Seite 21)
6	Colour selection (See page 18)	Selezione colore (Vedi pagina 18)	Choix de couleur (Voir page 18)	Selección de color (Ver página 18)	Farbauswahl (siehe Seite 18)
7	Beam angle	Angolo del fascio luminoso	Angle du faisceau lumineux	Ángulo del haz de luz	Winkel des Lichtstrahls
8	Dimensional Drawing And data	Disegno Dimensionale E dati	Dessin Dimensionnel et données	Dibujo dimensional y datos	Maßzeichnung und Daten
9	Accessoires	Accessori	Accessoires	Accesorios	Zubehör

LEGENDA

5 PRODUCT CHARACTERISTICS TABLE

	EN	IT	FR	ES	DE
A	Code	Codice	Code	Código	Code
B	Diffuser	Diffusore	Diffuseur	Difusor	Diffusor
C	Size	Misura	Taille	Tamaño	Größe
D	It identifies the out flux based on the theoretical values related to optical and thermal performance	Indica il flusso emesso calcolato utilizzando i valori teorici relativi al rendimento ottico e termico.	Il indique le débit émis calculé à l'aide des valeurs théoriques relatives aux rendements optique et thermique.	Indica el flujo emitido calculado utilizando los valores teóricos relativos a la eficiencia óptica y térmica.	Es gibt den emittierten Fluss an, der anhand der theoretischen Werte für den optischen und thermischen Wirkungsgrad berechnet wurde.
E	It is the total power absorbed by power grid from the lighting fitting. The value includes the power consumption of the power supply with a thermally stabilized device operating in an environment at 25 ° c.	È la potenza totale assorbita dalla rete elettrica dall'apparecchio di illuminazione. Il dato indicato è comprensivo dei consumi dell'alimentatore elettronico con apparecchio stabilizzato a regime termico operante in ambiente con temperatura pari a 25°C.	Puissance totale absorbée par le réseau électrique de l'appareil d'illumination. La donnée indiquée inclut la consommation de l'alimentateur électronique avec un appareil stabilisé à un régime thermique travaillant dans un milieu dont la température est égale à 25°C."	Es la potencia total absorbida por la red eléctrica del instrumento de iluminación. El dato indicado incluye el consumo del alimentador electrónico con equipo estabilizado a régimen térmico operante en un ambiente de temperatura igual a 25°C"	Es ist die gesamt Leistung, die das elektrische Netz von der Beleuchtungs einrichtung absorbiert. Das angegebene Datum beinhaltet den Verbrauch der elektronischen Stromversorgung, wobei sich die Geräte im thermischen Bereich stabilisiert haben und in einer Umgebung mit einer Temperatur von 25 ° c betrieben werden.
F	It identifies the colour temperature of the leds expressed in kelvin degrees	Indica la temperatura di colore dei led espressa in gradi kelvin.	Indique la température de couleur des led exprimée en degrés kelvin.	Indica la temperatura de color de los leds expresada en grados kelvin.	Gibt die Farbtemperatur der Leds in Kelvin an.
G	Beam angle	Angolo del fascio luminoso	Angle du faisceau lumineux	Ángulo del haz de luz	Winkel des Lichtstrahls
H	Driver type	Tipo di driver	Type de conducteur	Tipo de conductor	Treibertyp
I	Driver no.	Numero di driver	Nombre de conducteurs	Número de conductores	Treiberanzahl
L	Colour	Colore	Couleur	Color	Farbe

A CODE ORDERING COMPOSITION EXAMPLE

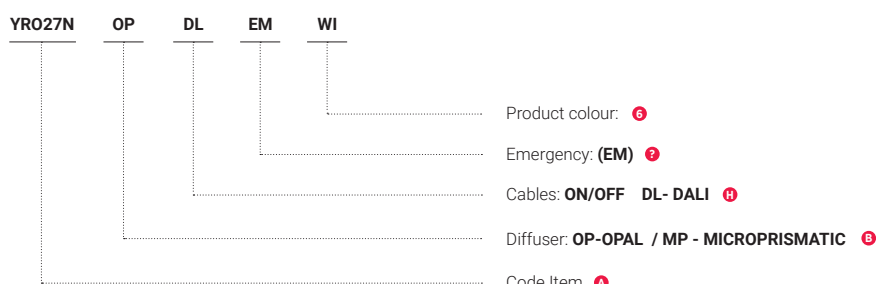

LEGENDA









POSSIBLE APPLICATIONS

APPLICAZIONI POSSIBILI | APPLICATIONS POSSIBLES | POSIBLES APLICACIONES | MÖGLICHE ANWENDUNGEN | ВОЗМОЖНЫЕ ПРИМЕНЕНИЯ

	EN	IT	FR
	Suspension	Sospensione	Suspension
	Wall mounted	Applique	Applique
	Ceiling mounted	Plafone	Plafond
	Floor	Lampade da terra	Lampe de sol
	Table Lamp	Lampade da tavolo	Lampe de table

SYMBOLS OF TECHNICAL DETAILS

SIMBOLI DEI DATI TECNICI | SYMBOLES DE DONNÉES TECHNIQUES | SÍMBOLOS DE DATOS TÉCNICOS | TECHNISCHE DATEN SYMBOLE
ТЕХНИЧЕСКИЕ ОБОЗНАЧЕНИЯ

	EN	IT	FR
	Led is the acronym for LIGHT EMISSION DIODE.	LED è l'acronimo per LIGHT EMISSION DIODE.	LED est l'acronyme de LIGHT EMISSION DIODE.
	Indicates that the product meets the requirements of the applicable EC Directives of the regulations in the EU.	Indica che il prodotto è conforme ai requisiti di sicurezza richiesti dalle direttive e dalle normative della Comunità Europea.	Certifie que le produit est réalisé au sein de l'Union Européenne et dans le respect des normes de sécurités en vigueur.
	Isolation class 1.	Classe di isolamento 1.	Classe d'isolation 1.
	Isolation class 2.	Classe di isolamento 2.	Classe d'isolation 2.
	CRI (Colour Rendering index) indicates how natural the colours of the illuminated objects look.	CRI (Colour Rendering index) Indica quanto naturali appaiano i colori degli oggetti da essa illuminati.	CRI (Colour Rendering index) Indique le rendement des couleurs des objets éclairés.
	Indicates the protection degree of the fixture against dust and water.	Rappresenta il grado di protezione dell'apparecchio dalla polvere e dall'acqua.	Indique le degré de protection de l'appareil contre les poussières et l'eau.
	Indicates the operating voltage of the fitting.	Indica le tensioni operative dell'apparecchio.	Indique les tensions de travail de l'appareil.
	Indicates the operating frequencies of the fitting.	Indica le frequenze operative dell'apparecchio.	Indique les fréquences de frctionnement de l'appareil.

ES	DE
Suspension	Hängemontage
Pared	Wandbeleuchtungsgerät
De techo	Deckenbeleuchtungsgerät
Luminaria de suelo	Stehleuchte
Luminaria de mesa	Tischlampe

ES	DE
LED es el acrónimo de LIGHT EMISSION DIODE.	LED ist das Akronym für LIGHT EMISSION DIODE.
Certifica que el producto es realizado en el ambito de la Comunidad Europea y respeta las normas de seguridad vigentes.	Gibt an, dass das Produkt den Sicherheitsanforderungen der Richtlinien und Verordnungen der Europäischen Gemeinschaft entspricht.
Clase de aislamiento 1.	Isolationsklasse 1.
Clase de aislamiento 2.	Isolationsklasse 2.
CRI (Colour Rendering index) Indica el nivel de apariencia naturallos colores de los objetos iluminados.	CRI (Colour Rendering index) Gibt an, wie natürlich die Farben der von ihm beleuchteten Objekte erscheinen.
Indica el grado de proteccion de la luminaria al polvo y al agua.	Sie gibt den Schutzgrad des Geräts vor Staub und Wasser an.
Indica las tensiones operativas de la luminaria.	Zeigt die Betriebsspannungen des Geräts an.
Indica las frecuencias operativas de la luminaria.	Zeigt die Betriebsfrequenzen des Geräts an.

LEGENDA

SYMBOLS OF TECHNICAL DETAILS

SIMBOLI DEI DATI TECNICI | SYMBOLES DE DONNÉES TECHNIQUES | SÍMBOLOS DE DATOS TÉCNICOS | TECHNISCHE DATEN SYMBOLE
ТЕХНИЧЕСКИЕ ОБОЗНАЧЕНИЯ

	EN	IT	FR
	Degree of Protection against external mechanical impact.	Indica il grado di resistenza all'urto dell'involucro esterno dell'apparecchio.	Indique le degré de protection de l'emballage du produit contre les impacts mécaniques externes.
	It indicates the flammability degree of plastic materials according to CEI 50-11 standards.	Indica il grado di infiammabilità dei materiali plastici in accordo alle normative CEI 50-11.	Indique le degré d'auto-extinction des matières plastiques selon les standards CEI 50-11.
	Integrated power supply.	Alimentatore integrato.	Alimentation intégrée.
	Separate power supply.	Alimentatore separato.	Alimentation séparée.
	Energy consumption class.	Classe energetica.	Classe de consommation d'énergie.
	Fitting with safety transformer. All parts under voltage, which may accidentally get in contact with the operator during the maintenance phases and installation, don't contain any dangerous voltage.	Apparecchio realizzato con trasformatore di sicurezza in cui tutte le parti in tensione che potrebbero entrare accidentalmente in contatto con l'operatore durante le fasi di manutenzione ed installazione, non contengono tensioni pericolose (<60V massimi a valle dell'alimentatore).	Appareil réalisé avec transformateur de sécurité où toutes les parties en tension, qui pourraient entrer accidentellement en contact avec l'opérateur pendant l'entretien et l'installation, ne contiennent pas de tensions dangereuses (<60V max en aval).
	Indica il valore massimo espresso con numero di ellissi di Mac Adam relativo alla selezione del CHIP LED.	It identifies the maximum value relative the selection of the CHIP LED expressed with number Mac Adam of ellipses.	La taille réduite de l'ellipse Mc Adam est l'indice de qualité chromatique de la LED.
	Apparecchio idoneo per l'utilizzo in ambienti interni.	Fitting suitable for internal environments use.	Appareil adapté pour installation à l'intérieur
	Glare index.	Indice di abbagliamento.	Indice d'éblouissement.
	Electrical wiring with data management DALI system.	Schema di collegamento per sistemi DALI.	Schéma de connexion pour appareil DALI.
	Emergency Module in accordance with Norm EN 60598-2-22 available on request.	Emergenza conforme alla norma EN 60598-2-22 disponibile su richiesta.	Groupe d'urgence selon EN 60598-2-22 disponible sur demande.
	Warranty More details on our website.	Garanzia maggiori dettagli alla nostra pagina web.	Garantie plus de détails sur notre page Web.
	Service Life LED.	Aspettativa di vita del LED.	Durée de vie LED.

ES	DE
Indica el grado de resistencia al impacto de la cubierta externa de la luminaria.	Zeigt den Grad der Schlagfestigkeit des äußeren Gehäuses des Geräts an.
Indica el grado de auto extinción del material plástico según los estándares estadounidense CEI 50-11.	Gibt den Entzündbarkeitsgrad von Kunststoffen gemäß CEI 50-11 an.
Fuente de alimentación integradal.	Integrierte Stromversorgung.
Fuente de alimentación separada.	Separate Stromversorgung.
Clase de consumo de energía.	Energieverbrauchsklasse.
Luminaria realizada contras transformador de seguridad cuyos componentes que accidentalmente pudieran entrar en contacto con el operador durante las etapas de mantenimiento o instalación, no contienen tensión peligrosa (<60 máxima después del balastro).	Gerät mit Sicherheitstransformator, bei dem alle spannungsführenden Teile, die während der Wartungs- und Installationsphasen versehentlich mit dem Bediener in Berührung kommen könnten, keine gefährlichen Spannungen enthalten (maximal <60 V nach der Spannungsversorgung).
Índice de deslumbramiento.	Blendungsindex.
Esquema de conexión luminaria DALI.	Anschlussplan für DALI-Systeme.
Emergencia según EN 60598-2-22 disponible bajo pedido.	Notfall gemäß EN 60598-2-22 auf Anfrage erhältlich.
Garantía más detalles en nuestra página web.	Garantie mehr Details auf unserer Webseite.
Víad Util LED.	Lebenswartung LED.

INDEX

ANALITICAL PRODUCTS INDEX

Code	Page	Code	Pag	Code	Page	Code	Page	Code	Page
YAD13N	111	YCI32N	81	YJE15N	101	YRO90N	73	YSCT40W	239
YAD13W	111	YCI32W	81	YJE15W	101	YRO90W	73	YSEE15N	49
YAD18N	111	YCI48N	81	YLI11N	115	YROI27N	69	YSEE15W	49
YAD18W	111	YCI48W	81	YLI11W	115	YROI27W	69	YSEE16N	49
YAD23N	111	YCI64N	81	YLI15N	115	YROI36N	69	YSEE16W	49
YAD23W	111	YCI64W	81	YLI15W	115	YROI36W	69	YSEE20N	49
YAL16N	143	YDO23N	179	YLI16N	247	YROI55N	69	YSEE20W	49
YAL16W	143	YDO23W	179	YLI16W	247	YROI55W	69	YSEE21N	49
YAQ11N	89	YDO40N	179	YMAM36N	187	YROI75N	69	YSEE21W	49
YAQ11W	89	YDO40W	179	YMAM36W	187	YROI75W	69	YSEI15N	51
YAQ15N	89	YDO60N	179	YMAM60N	187	YRSI03N	57	YSEI15W	51
YAQ15W	89	YDO60W	179	YMAM60W	187	YRSI03W	57	YSEI16N	51
YAR10N	61	YDU23N	175	YMAS36N	187	YRSI06N	57	YSEI16W	51
YAR10W	61	YDU23W	175	YMAS36W	187	YRSI06W	57	YSEI20N	51
YAR12N	61	YDU40N	175	YMAS60N	187	YRSI10N	57	YSEI20W	51
YAR12W	61	YDU40W	175	YMAS60W	187	YRSI10W	57	YSEI21N	51
YAR15N	61	YDU60N	175	YNO29W	191	YRSI12N	57	YSEI21W	51
YAR15W	61	YDU60W	175	YNR11N	97	YRSI12W	57	YSLD15N	37
YAR20N	61	YEL11N	93	YNR11W	97	YRSI15N	57	YSLD15W	37
YAR20W	61	YEL11W	93	YNR15N	97	YRSI15W	57	YSLD16N	37
YAR30N	61	YEL15N	93	YNR15W	97	YRSI17N	57	YSLD16W	37
YAR30W	61	YEL15W	93	YOL58N	85	YRSI17W	57	YSLD20N	37
YARI10N	63	YES30N	171	YOL58W	85	YSAD15N	29	YSLD20W	37
YARI10W	63	YES30W	171	YOP11N	119	YSAD15W	29	YSLD21N	37
YARI12N	63	YES40N	171	YOP11W	119	YSAD16N	29	YSLD21W	37
YARI12W	63	YES40W	171	YOP15N	119	YSAD16W	29	YSLI15N	39
YARI15N	63	YES60N	171	YOP15W	119	YSAD20N	29	YSLI15W	39
YARI15W	63	YES60W	171	YPL30N	199	YSAD20W	29	YSLI16N	39
YARI20N	63	YES90N	171	YPL30W	199	YSAD21N	29	YSLI16W	39
YARI20W	63	YES90W	171	YRO120N	73	YSAD21W	29	YSLI20N	39
YARI30N	63	YFAFM145	151	YRO120W	73	YSAI15N	33	YSLI20W	39
YARI30W	63	YFAM14N	151	YRO27N	67	YSAI15W	33	YSLI21N	39
YBOFM385	203	YFAM14W	151	YRO27W	67	YSAI16N	33	YSLI21W	39
YBOM39N	203	YGI18N	183	YRO36N	67	YSAI16W	33	YSMD18N	129
YBOM39W	203	YGI18W	183	YRO36W	67	YSAI20N	33	YSMD18W	129
YCA21N	155	YGI41N	183	YRO55N	67	YSAI20W	33	YSMD19N	129
YCA21W	155	YGI41W	183	YRO55W	67	YSAI21N	33	YSMD19W	129
YCA41N	155	YGI80N	183	YRO60N	73	YSAI21W	33	YSMD20N	129
YCA41W	155	YGI80W	183	YRO60W	73	YSCT39N	239	YSMD20W	129
YCA61N	155	YJE11N	101	YRO75N	67	YSCT39W	239	YSMD21N	129
YCA61W	155	YJE11W	101	YRO75W	67	YSCT40N	239	YSMD21W	129

INDEX

ANALITICAL PRODUCTS INDEX

Code	Page	Code	Page	Code	Page	Code	Page	Code	Page
YSMD30N	129	YSRE03W	55	YSVD15N	23	YTAM32N	165	YZO40N	161
YSMD30W	129	YSRE06N	55	YSVD15W	23	YTAM32W	165	YZO40W	161
YSMD31N	129	YSRE06W	55	YSVD16N	23	YTI22N	147	YZO60N	161
YSMD31W	129	YSRE10N	55	YSVD16W	23	YTI22W	147	YZO60W	161
YSMI18N	131	YSRE10W	55	YSVD20N	23	YTI30N	147	YZOFM225	159
YSMI18W	131	YSRE12N	55	YSVD20W	23	YTI30W	147	YZOFM395	159
YSMI19N	131	YSRE12W	55	YSVD21N	23	YTI50N	147	YZOFM595	159
YSMI19W	131	YSRE15N	55	YSVD21W	23	YTI50W	147	YZOM23N	159
YSMI20N	131	YSRE15W	55	YSVI15N	25	YTR15N	195	YZOM23W	159
YSMI20W	131	YSRE17N	55	YSVI15W	25	YTR15W	195	YZOM40N	159
YSMI21N	131	YSRE17W	55	YSVI16N	25	YUF10W	77	YZOM40W	159
YSMI21W	131	YSSD15N	43	YSVI16W	25	YZO23N	161	YZOM60N	159
YSMI30N	131	YSSD15W	43	YSVI20N	25	YZO23W	161	YZOM60W	159
YSMI30W	131	YSSD16N	43	YSVI20W	25				
YSMI31N	131	YSSD16W	43	YSVI21N	25				
YSMI31W	131	YSSD20N	43	YSVI21W	25				
YSP15N	251	YSSD20W	43	YSWI15N	139				
YSP15W	251	YSSD21N	43	YSWI15W	139				
YSPI25N	135	YSSD21W	43	YSWI16N	139				
YSPI25W	135	YSSI15N	45	YSWI16W	139				
YSPI26N	135	YSSI15W	45	YSWI20N	139				
YSPI26W	135	YSSI16N	45	YSWI20W	139				
YSPI30N	135	YSSI16W	45	YSWI21N	139				
YSPI30W	135	YSSI20N	45	YSWI21W	139				
YSPI31N	135	YSSI20W	45	YSWI25N	139				
YSPI31W	135	YSSI21N	45	YSWI25W	139				
YSPI40N	135	YSSI21W	45	YSWI26N	139				
YSPI40W	135	YST32N	259	YSWI26W	139				
YSPI41N	135	YST32W	259	YTA14N	167				
YSPI41W	135	YST39N	243	YTA14W	167				
YSQ43N	255	YST39W	243	YTA17N	167				
YSQ43W	255	YST40N	243	YTA17W	167				
YSQD60N	105	YST40W	243	YTA32N	167				
YSQD60W	105	YSUP15N	125	YTA32W	167				
YSQD80N	105	YSUP15W	125	YTAFM145	165				
YSQD80W	105	YSUP16N	125	YTAFM175	165				
YSQDI60N	107	YSUP16W	125	YTAFM325	165				
YSQDI60W	107	YSUP20N	125	YTAM14N	165				
YSQDI80N	107	YSUP20W	125	YTAM14W	165				
YSQDI80W	107	YSUP21N	125	YTAM17N	165				
YSRE03N	55	YSUP21W	125	YTAM17W	165				

ANALITICAL ACCESSOIRES INDEX	
YAQ11-KRO	89
YAQ15-KRO	89
YEL11-KRO	93
YEL15-KRO	93
YJE11-KRO	101
YJE15-KRO	101
YKT10207	115
YKT10209D	115
YKT10209S	115
YKT10301	23/119
YKT10401	23/57
YKT10402	55/57
YKT10501	23/119
YKT35	61/69
YKT45	61/73
YKT65	61/63
YKTP35	61
YKTP45	61
YKTP65	61
YNR11-KRO	97
YNR15-KRO	97

YOP11-KRO	119
YOP15-KRO	119
YSEKTRO	49/51
YSR-KRO230	55
YSR-KRO290	55

CONNECTION SCHEME

ON/OFF

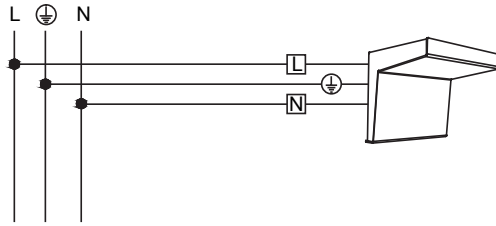

PUSH DIM

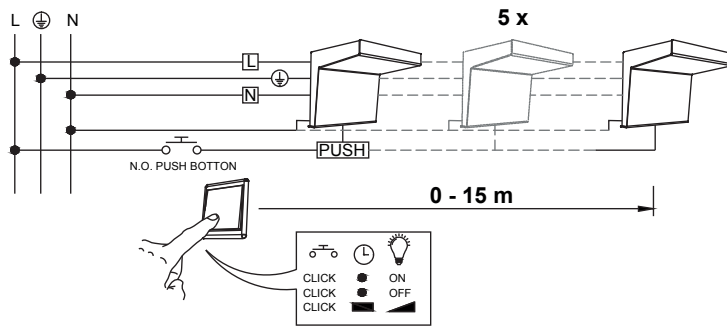

DALI

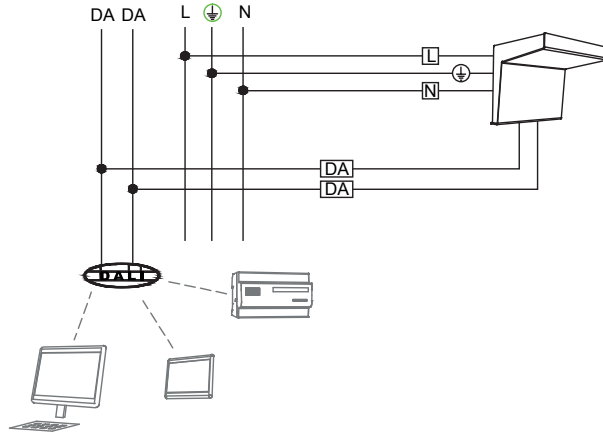

EM

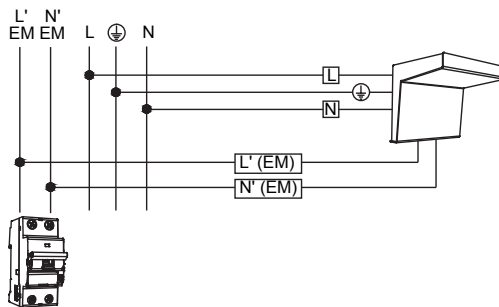

CONDIZIONI GENERALI DI VENDITA

1. PREMESSE

Le forniture comprendono solo quanto espressamente specificato nella conferma di accettazione dell'ordine della ditta Venditrice e sono regolate dalle presenti condizioni generali, salvo deroghe risultanti da esplicito accordo scritto. Eventuali variazioni o comunicazioni durante il corso della fornitura non costituiscono invalidazione del contratto. I termini di consegna convenuti hanno valore indicativo e non tassativo. In qualunque momento l'esecuzione della fornitura potrà essere sospesa in caso di mutamento nelle condizioni patrimoniali del Committente ai sensi dell'Art. 1461 del Codice Civile.

2. PREZZI

I prezzi si intendono Franco Fabbrica della ditta Venditrice. Essi non comprendono prestazioni ed oneri non menzionati. Gli imballaggi sono inclusi nel prezzo, salvo diversa pattuizione scritta.

3. VARIABILITA' PREZZI

I prezzi indicati nel contratto sono stati calcolati in base ai costi dei materiali e della manodopera alla data del contratto stesso, in base alle relative tabelle dell'ANIE. Il sistema di calcolo delle variazioni di qualsiasi entità in più o in meno, che dovessero verificarsi sui detti costi durante il periodo dell'esecuzione della vendita, verrà effettuato in base alle clausole di variabilità prezzi vigenti per apparecchi di illuminazione pubblicato dall'ANIE.

4. MODALITA' DI PAGAMENTO

Si riconoscono solo i pagamenti fatti direttamente al nostro domicilio o a persone da noi autorizzate.

5. RISERVA DI PROPRIETA'

La ditta Venditrice conserva la proprietà sui materiali fino a totale pagamento di essi, ma i rischi sono assunti dal compratore sin dalla consegna. Qualunque atto del Committente che, salvo esplicito consenso scritto della Ditta venditrice, involga pregiudizio al diritto della Ditta Venditrice alla rivendita del materiale, sarà sottoposto alle sanzioni di legge.

6. CONSEGNA

Il termine di consegna indicato non impegna la Ditta Venditrice, la quale non è tenuta a corrispondere indennizzi di sorta per eventuali danni diretti ed indiretti dovuti a ritardi di consegna o ad interruzione od a risoluzione parziale o totale della fornitura. Il termine di consegna decorre dalla data della conferma d'ordine e in ogni caso non ha inizio prima del ricevimento della rata di pagamento all'ordine quando essa sia stata concordata. Esso si intende di diritto adeguatamente prorogato se i pagamenti non vengono effettuati puntualmente, se il Committente manca di fornire in tempo utile quanto stabilito nel contratto o se comunque insorgono cause indipendenti dalla Ditta Venditrice, ivi compresi eventuali ritardi di subfornitori.

7. RESO MERCE

La merce può essere resa esclusivamente previa autorizzazione della Ditta Venditrice con un deprezzamento minimo del 30%.

8. TRASPORTO

La merce viaggia rischio e pericolo del Committente comprese le eventuali rotture anche se spedita in porto franco. Trascorsi 8 giorni dal ricevimento non si accettano reclami. Gli ordini saranno evasi secondo la disponibilità e le spedizioni potranno essere fatte anche parzialmente.

9. DATI TECNICI

I materiali forniti, salvo diverse particolari prescrizioni da concordarsi per iscritto, corrispondono alle vigenti norme del CEI - Comitato Elettrotecnico Italiano, ove queste siano applicabili. La ditta Venditrice si riserva di apportare in qualunque momento ai propri prodotti quelle modifiche che ritenesse tecnicamente convenienti. I disegni della Ditta Venditrice sono di sua proprietà e non possono dal Committente essere consegnati a terzi né prodotti senza autorizzazione scritta.

10. GARANZIA

Ideallux garantisce i suoi prodotti per 24 mesi dalla data di fabbricazione indicata sul prodotto. La garanzia copre tutti i difetti di fabbricazione siano essi di natura meccanica o elettronica. Non sono inclusi in garanzia tutti i danni causati dalla movimentazione e/o utilizzo errato e non conforme a quanto riportato sulle istruzioni d'uso. La garanzia decade nel caso in cui i prodotti vengano manomessi e/o modificati.

Il prodotto difettoso per cui è richiesto l'intervento in garanzia, può essere riparato o sostituito con un articolo complementare sia nuovo che ricondizionato ad insindacabile giudizio di Ideallux. I prodotti che riportano il marchio "5 years warranty" sono coperti da 5 anni di garanzia considerando 14h/giorno per 365 giorni solari annuali, nel rispetto del lifetime indicato sulla scheda prodotto. I reclami per interventi in garanzia entro i 5 anni dalla data di fabbricazione (ad esclusione di quelli ricevuti entro i termini legislativi sopra indicati) saranno soggetti ad approvazione di Ideallux. Guasti che rientrano nella difettosità fisiologica dichiarata e comunque entro il 5% del totale degli articoli installati non sono coperti dalla garanzia 5 anni. Termini e condizioni generali di garanzia sono disponibili e possono essere richiesti presso la sede Ideallux.

11. CONTROVERSIE

I contratti, anche se stipulati con cittadini esteri o per materiali forniti all'estero, sono regolati dalla vigente legislatura italiana. Foro competente è soltanto quello avente giurisdizione nella sede legale della Ditta Venditrice anche in deroga agli art. 32 e seguenti del Codice di Procedura Civile, esclusa per il Committente la possibilità di adire l'Autorità Giudiziaria di altro luogo anche in via di garanzia o di connessione di causa, ma salva la facoltà alla Ditta Venditrice di esperire, in qualità di attrice, un'azione nel luogo di residenza, in Italia o all'estero, del Committente. Le eventuali contestazioni non dispensano il Committente dall'osservare le condizioni di pagamento pattuite e non implicano alcun prolungamento dei termini convenuti. Le spese di contratto, la sua registrazione e l'eventuale trascrizione sono a carico del Committente.

GENERAL SALES CONDITIONS

1. INTRODUCTION

The supplies include only what is expressly specified in the order acceptance confirmation of the Vending Company and are governed by these general conditions, save for provisions resulting from an explicit written agreement. Any changes or notifications during the supply do not constitute the invalidation of the contract. The agreed delivery terms are merely indicative and are not binding. The execution of the supply may be suspended at any time due to changes to the financial conditions of the Buyer in accordance with the Art. 1461 of the Italian Civil Code.

2. PRICES

The prices are Ex-works of the Vending Company and do not include services at charges that have not been mentioned. The packages are included in price. The package cannot be returned, save for a different written agreement.

3. CHANGES IN PRICES

The prices shown in the contract were calculated based on the costs of the materials and of the labor on the date of the contract based on the related ANIE tables. The calculation system of any kind of changes, whether more or less, that may arise to said costs during the period of execution of the sale will be carried out based on the clauses of the changes of prices in force for lighting equipment published by ANIE.

4. PAYMENT

We recognize as valid payment only the ones made directly to our address or to our authorized people.

5. RETENTION OF TITLE

The Vending Company keeps the ownership of materials until paid in full, but the risks are assumed by the Buyer upon delivery. Any action of the Buyer, that results in prejudice to the right of the Vending Company to resell the material, will be subjected to legal sanctions, save for the explicit written consent of the Vending Company.

6. DELIVERY

The delivery period shows does not bind the Vending Company, which is not bound to pay indemnities arising for any direct or indirect damage due to delivery delays, downtime or the partial or total return of the supply. The delivery period is effective from the date of the order confirmation and in any case does not begin prior to having received the payment instalment for the agreed amount. This term is adequately extended by right if the payments are not made punctually, if the Buyer fails to supply what is set out in the contract in useful time or if causes nonetheless arise regardless of the Vending Company, therein including any delays of sub-contractors.

7. RETURN OF GOODS

The goods may only be returned upon the authorization of the Vending Company and with a depreciation of 30%.

8. TRANSPORT

The goods travel at Customer's risks and danger, even if in case of damage in fall of delivery terms Free destination.

9. TECHNICAL DATA

Save for special prescriptions to be agreed in writing, the materials supplied correspond to the standards in force of the CEI (Italian Electrical and Technical Council), where applicable. The Vending Company reserves the right to change its products at any time where deemed technically convenient. The designs of the Vending Company are its own property and may not be given by the Buyer to third parties without written authorization.

10. WARRANTY

IDEALLUX guarantees its products for 24 months from the date of production indicated on the item. The warranty covers all manufacturing defects whether they are of a mechanical or electronic nature. All damage caused by handling and / or incorrect use, or use not in accordance with the instructions indicated in the operating instructions are not covered by this warranty. The warranty will expire if the products are tampered with and / or modified. The defective product requiring warranty intervention can be repaired or replaced with a similar article both new and reconditioned at the discretion of Ideallux. The products with mark "5 years warranty" are covered by 5 years warranty considering 14 h / day for 365 solar annual days, respecting the lifetime indicated in the product data sheet. Claims for warranty work within 5 years from the date of manufacture (except those received within the above mentioned legislative terms) will be subject to Ideallux approval. Faults that fall within the declared physiological defect and in any case within 5% of the total installed items will not be covered by the 5 years warranty. Warranty general terms and conditions are available and can be requested at Ideallux offices.

11. DISPUTES

Even if stipulated with foreign citizens or for materials supplied abroad, the contracts are governed by the Italian legislation in force. The only competent court is the one having jurisdiction in the registered office of the Vending Company, also in provision of Art. 32 and ff. of the Italian Code of Civil Procedure, apart from the Buyer's possibility of applying to the Judicial Authority of another place also as a guarantee or related cause, but save for the right of the Vending Company to carry out an action in the place of residence of the Buyer in Italy or abroad as the plaintiff. Any disputes do not waive the Buyer from observing the agreed payment conditions and do not imply any extension of the agreed terms. The costs of the contract, its registration and transcription are at the expense of the Buyer.

CONDITIONS GÉNÉRALES DE VENTE

1. GÉNÉRALITÉS

Les fournitures comprennent exclusivement les indications expressément spécifiées dans la confirmation d'acceptation de la commande par le vendeur et sont réglementées par les conditions générales présentes, sauf en cas de dérogations résultant d'accord écrit explicite. Des variations éventuelles ou des communications durant le déroulement de la fourniture ne constituent pas d'invalidation du contrat. Les termes de livraison convenus ont une valeur indicative et non impérative. À tout moment, l'exécution de la fourniture pourra être suspendue en cas de changement dans les conditions patrimoniales du Client aux termes de l'article 1461 du Code Civil.

2. PRIX

Les prix sont départ usine du vendeur, ils ne comprennent pas les charges pour prestations non mentionnées. Les emballages ne sont pas à retourner, sauf en cas de convention contraire écrite.

3. VARIATIONS DES PRIX

Les prix indiqués dans le contrat ont été calculés en fonctions des coûts des matériaux et de la main d'œuvre à la date du contrat, en fonction des tableaux de l'ANIE correspondants. Le système de calcul des variations de toute entité en plus ou en moins qui aurait lieu sur ces coûts durant la période de l'exécution de la vente, sera effectué en fonction des clauses de variation des prix en vigueur pour les appareils d'éclairage publiées par l'ANIE.

4. MODALITÉS DE PAIEMENT

Les paiements pourront être effectués uniquement au domicile du vendeur ou à des personnes autorisées.

5. RÉSERVE DE PROPRIÉTÉ

Le Vendeur conserve la propriété sur les matériels jusqu'au paiement total de ceux-ci mais les risques sont assumés par l'acheteur dès la livraison. Tout acte du Client, sauf en cas de consentement écrit explicite du vendeur, qui porterait préjudice au droit du Vendeur en cas de revente du matériel sera soumis à des sanctions légales.

6. LIVRAISON

Le délai de livraison indiqué n'engage pas le Vendeur et ne pourra pas donner droit à des indemnités d'aucune sorte pour d'éventuels dommages directs et indirects dus à des retards de livraison ou à une suspension ou à une résolution partielle ou totale de la fourniture. Le délai de livraison prend effet à partir de la date de confirmation de commande et dans tous les cas ne commence pas avant la réception du paiement de l'acompte de la commande si prévu. Sa prorogation est légalement valable : en cas de paiements qui ne seraient pas effectués ponctuellement, si le Client ne fournit pas en temps utile ce qui est établi sur le contrat ou si des imprévus indépendants de la volonté du Vendeur surviennent, y compris des retards éventuels des sous-traitants.

7. REPRISE DE LA MARCHANDISE

La marchandise peut être vendue exclusivement avec l'accord du vendeur et avec une dépréciation de 30 %.

8. TRANSPORT

La marchandise voyage aux risques et périls du Client y compris les éventuelles ruptures même si l'expédition est franco destination. Le Vendeur n'acceptera pas de réclamations au-delà du délai de 8 jours à partir de la date de réception. Les commandes seront expédiées selon les disponibilités et les expéditions pourront être effectuées même partiellement.

9. DONNÉES TECHNIQUES

Les matériaux fournis, sauf en cas de prescriptions particulières à indiquer par écrit, correspondent aux normes en vigueur du CEI – Comité Electrotechnique Italien là où elles sont applicables. Le vendeur se réserve le droit d'apporter toute modification qu'il retient techniquement appropriée à tout moment aux propres produits. Les dessins des Vendeurs sont de sa propriété et le Client ne peut pas les céder à un tiers, ni les diffuser sans autorisation écrite.

10. GARANTIE

Ideallux garantit tous ses produits pendant 24 mois à partir de la date de fabrication indiquée sur le produit. La garantie couvre tous les défauts de fabrication de nature mécanique ou électronique. Tous les dommages causés par l'entretien et/ou l'utilisation incorrecte et non conforme aux indications figurant sur la notice sont exclus de la garantie. La garantie n'est pas valable en cas détérioration et/ou modification des produits. Le produit défectueux pour lequel on demande un SAV sous garantie, peut être réparé ou remplacé par un article identique neuf ou reconditionné après décision, sans appel, de Ideallux. Les produits portant la mention "5 years warranty" sont couverts par une garantie de 5 ans considérant 14 heures/jour pendant 365 jours, dans le respect de la durée de vie (lifetime) indiquée sur la fiche technique du produit. Les réclamations pour des interventions en garantie durant les 5 années à partir de la date de fabrication (exceptées celles reçues dans les délais légaux indiqués ci-dessus) seront soumises à l'approbation de Ideallux. Les pannes faisant partie d'un défaut physiologique déclaré et à hauteur de 5 % du total des articles installés ne sont pas couverts par la garantie de 5 ans. Les termes et conditions générales de garantie sont disponibles et peuvent être demandés au siège de Ideallux.

11. CONTROVERSES

Les contrats, même stipulés avec des citoyens étrangers ou pour des matériaux fournis à l'étranger, sont réglementés par la législation italienne en vigueur. Le tribunal compétent est exclusivement celui de la juridiction du siège légal du Vendeur même en cas de dérogation aux art. 32 et art. suivants du Code de Procédure Civile, le client n'ayant pas la possibilité de recourir aux voies légales d'un autre lieu même à titre de garantie ou de connexité. Le Vendeur a la faculté d'avoir recours, en qualité d'acteur, à une action en justice sur le lieu de résidence du Client, en Italie ou à l'étranger. Les contestations éventuelles ne dispensent pas le client d'observer les conditions de paiement accordées et n'impliquent aucunement le prolongement des termes convenus. Les frais de contrat, son enregistrement et sa transcription éventuelle sont à la charge du Client.

CONDICIONES GENERALES DE VENTA

1. PREMISAS

Los suministros incluyen solamente lo expresamente especificado al confirmar la aceptación del pedido de la Compañía Vendedora y son regulados por las presentes condiciones generales, salvo excepción resultante de un explícito acuerdo por escrito. Posibles variaciones o comunicaciones durante el transcurso del suministro no constituyen la invalidación del contrato. Los plazos de entrega convenidos tienen valor indicativo y no perentorio. En cualquier momento la ejecución del suministro podrá ser suspendida en caso de modificación de las condiciones patrimoniales del Cliente a efectos del Art. 1461 del Código Civil italiano.

2. PRECIOS

Los precios se suponen Franco Fábrica de la Compañía Vendedora. Los mismos no incluyen prestaciones ni cargos no mencionados. Los embalajes se consideran incluidos en el precio, salvo acuerdo contrario por escrito.

3. VARIACIÓN DE PRECIOS

Los precios indicados en el contrato han sido calculados según los costes del material y de la mano de obra a la fecha del contrato mismo, según el índice correspondiente de la ANIE (Asociación industrial italiana del sector eléctrico y electrónico). El cálculo del as variaciones de cualquier índole, que pudieren verificarse sobre dichos costes durante el periodo de ejecución de la venta, se efectuará según las cláusulas de variación de los precios vigentes para luminarias publicado por la ANIE.

4. FORMA DE PAGO

Se reconocen solamente los pagos efectuados directamente a nuestro domicilio o a nuestro personal autorizado.

5. RESERVA DE DOMINIO

La Compañía Vendedora mantiene la propiedad sobre los materiales hasta el pago total de estos, pero los riesgos son asumidos por parte del comprador desde el momento de la entrega. Cualquier acto del Cliente que, salvo explícito consentimiento por escrito de la compañía vendedora, afecte el derecho del Vendedor a la reventa del material, estará sujeto a las sanciones establecidas por la ley.

6. ENTREGA

El plazo de entrega indicado no compromete a la empresa Vendedora, la cual no está obligada a pagar indemnizaciones de ningún tipo por eventuales daños directos o indirectos como consecuencia de retrasos en la entrega o interrupción o terminación parcial o total del suministro de productos. El plazo de entrega corre desde la fecha de confirmación del pedido y en todo caso no comienza hasta la recepción de la cuota de pago en el plazo acordado. Dicho plazo se considerará automáticamente prorrogado si los pagos no se efectúan puntualmente, si el Cliente no proporciona a tiempo lo establecido en el contrato o si de todos modos surgen causas independientes de la empresa Vendedora, incluidas demoras por parte de subcontratistas.

7. DEVOLUCIÓN

La mercadería se puede devolver exclusivamente previa autorización de la empresa Vendedora y con una depreciación mínima del 30%.

8. TRANSPORTE

La mercadería viaja a riesgo y responsabilidad del Cliente incluidas las posibles roturas incluso cuando fuese enviada con porte pagado. Transcurridos ocho días de la recepción no se aceptan reclamos. Los pedidos serán despachados según la disponibilidad y los envíos pueden realizarse parcialmente.

9. DATOS TÉCNICOS

Los materiales suministrados, a menos que se acuerde lo contrario por escrito, corresponden a las normas vigentes del CEI – Comité Electrotécnico Italiano, donde estas sean aplicables. La empresa Vendedora se reserva el derecho de aportar en cualquier momento a sus productos aquellas modificaciones que considere técnicamente convenientes. Los diseños de la empresa Vendedora son de su absoluta propiedad y no pueden ser entregados por el Cliente a terceros ni reproducidos sin previa autorización escrita.

10. GARANTÍA

Ideallux garantiza sus productos por 24 meses a partir de la fecha de fabricación indicada en el producto. La garantía cubre todo defecto de fabricación sea el mismo de índole mecánica o electrónica. No están incluidos en la garantía los daños causados por manipulación y/o uso incorrectos o no conforme a lo escrito en las instrucciones de uso. La garantía queda sin efecto en el caso en que los productos fuesen alterados y/o modificados. El producto defectuoso por el cual se solicita la intervención de la garantía, puede ser reparado o sustituido con un artículo complementario nuevo o reacondicionado a criterio indiscutible de Ideallux. Los productos que llevan la marca "5 years warranty" están cubiertos por 5 años de garantía considerando 14h/día por 365 días anuales, respetando la vida útil indicada en la ficha del producto. Los reclamos para aplicación de la garantía dentro de los 5 años de la fecha de fabricación (excepto aquellos recibidos antes de los términos legislativos ya indicados) serán sometidos a la aprobación de Ideallux. Aquellos desperfectos que se consideren dentro de la defectuosidad fisiológicamente declarada y en todo caso dentro del 5% del total de los artículos instalados no están cubiertos por la garantía de 5 años. Los plazos y las condiciones generales de garantía están disponibles y pueden ser requeridos a la sede de Ideallux.

11. LITIGES

Los contratos, mismo stipulés avec des citoyens étrangers ou pour des matériaux fournis à l'étranger, sont réglementés par la législation italienne en vigueur. Le tribunal compétent est exclusivement celui de la juridiction du siège légal du Vendeur même en cas de dérogation aux art. 32 et art. suivants du Code de Procédure Civile italien, le client n'ayant pas la possibilité de recourir aux voies légales d'un autre lieu même à titre de garantie ou de connaissance de cause, en revanche le Vendeur a la faculté d'avoir recours, en qualité d'acteur, à une action en justice sur le lieu de résidence du Client, en Italie ou à l'étranger. Les contestations éventuelles ne dispensent pas le client d'observer les conditions de paiement accordées et n'impliquent aucunement le prolongement des termes convenus. Les frais de contrat, son enregistrement et sa transcription éventuelle sont à la charge du Client.

ALLGEMEINE VERKAUFSBEDINGUNGEN

1. ALLGEMEINES

Für alle Lieferungen und Leistungen gelten ausschließlich die nachstehenden Verkaufs- und Lieferbedingungen. Die Lieferungen enthalten nur was deutlich auf die Auftragsbestätigung angegeben. Einkaufsbedingungen des Bestellers verpflichten den Lieferanten nur, wenn sie von dem Lieferanten ausdrücklich schriftlich anerkannt werden. Jegliche Änderungen oder Mitteilungen während der Lieferung stellen keinen Rücktritt vom Vertrag dar. Die vereinbarten Lieferbedingungen sind unverbindlich und nicht verbindlich. Die Ausführung der Lieferung kann jederzeit im Falle einer Änderung der Kapitalkonditionen des Kunden ausgesetzt werden, gemäß dem Artikel 1461 des Zivilgesetzbuches.

2. PREISE

Die Preise gelten ab Werk oder Lager des Lieferanten. Sie enthalten keine Gebühren oder Dienstleistungen, die nicht erwähnt werden. Die Verpackungen sind enthalten, sofern nichts anderes schriftlich vereinbart ist.

3. PREISÄNDERUNG

Die im Vertrag angegebenen Preise wurden auf der Grundlage der Material- und Arbeitskosten zum Zeitpunkt des Vertrags berechnet, aus Basis der betreffenden Tabelle des ANIE. Das Berechnungssystem der Kostenänderungen wird auf Basis der gültige ANIE Preisvariabilitätsklauseln durchgeführt.

4. ZAHLUNGEN

Wir erkennen nur Zahlungen an, die direkt an unser Haus oder an von uns autorisierte Personen geleistet werden.

5. EIGENTUMSVORBEHALT

Die Lieferungen bleiben Eigentum des Lieferanten bis zur vollständigen Bezahlung der Materialien, aber die Risiken übernimmt der Käufer bereits ab Lieferung. Jede Handlung des Kunden, die das Recht des verkaufenden Unternehmens auf den Weiterverkauf des Materials beeinträchtigen kann, unterliegt gesetzlichen Sanktionen.

6. LIEFERTERMIN

Die angegebene Lieferzeit bindet die Verkäuferfirma nicht und sie ist nicht verpflichtet, irgendeine Entschädigung für direkte oder indirekte Schäden aufgrund von Lieferverzögerungen oder Unterbrechungen oder teilweiser oder vollständiger Auflösung der Lieferung zu zahlen. Der Lieferfrist beginnt ab das Auftragsbestätigungsdatum, und auf jeden Fall ab Zahlungseingang bis zur Bestellung, wenn dies vereinbart wurde. Es ist ein ausreichend erweitertes recht, wenn die Zahlungen nicht rechtzeitig geleistet werden, wenn der Kunde die vertraglich vereinbarten Fristen nicht rechtzeitig zur Verfügung stellt oder auf jeden Fall wenn die Ursachen unabhängig von der verkaufenden Gesellschaft auftreten, einschließlich möglicher Verzögerungen von Unterauftragnehmern.

7. RÜCKLIEFERUNGEN

Die Ware kann nur mit Genehmigung des Verkäufers und mit einer Mindestabschreibung von 30% zurückgegeben werden.

8. VERSAND

Die Ware reist auf Gefahr des Kunden, auch wenn der Versand frei Haus erfolgt

9. TECHNISCHE DATEN

Die gelieferten Materialien entsprechen den aktuellen CEI-Normen (wo diese zutreffen), sofern nicht besondere Anforderungen schriftlich vereinbart werden. Das Verkäuferunternehmen behält sich das Recht vor, jederzeit Änderungen an seinen Produkten vorzunehmen, wenn dies technisch angemessen erscheint. Die Zeichnungen des Verkäufers befinden sich in seinem Eigentum und können nicht ohne schriftliche Genehmigung vom Kunden an Dritte ausgeliefert oder hergestellt werden.

10. GARANTIE

Ideallux garantiert seine Produkte für 24 Monate ab das auf dem Artikel gedruckte Herstellungsdatum. Die Garantie deckt alle Herstellungsfehler ab, egal ob mechanisch oder elektronisch. Alle Schäden, die durch falsche Handhabung und / oder falsche Verwendung, die nicht den Gebrauchsanweisungen entsprechen, verursacht werden, sind nicht in der Garantie enthalten. Die Garantie erlischt, wenn die Produkte manipuliert und / oder verändert wurden. Das fehlerhafte Produkt, für das ein Garantieanspruch erforderlich ist, kann nach eigenem Ermessen von Ideallux repariert oder durch einen neuen oder überholten Zusatzartikel ersetzt werden. Die Produkte mit Mark „5 years warranty“ sind für 5 Jahre garantiert, berücksichtigen 14 Stunden pro Tag für 365 jährliche Kalendertage unter Beachtung der auf dem Produktblatt angegebenen Lebensdauer. Die Gewährleistungsansprüche innerhalb von 5 Jahren ab Herstellungsdatum (mit Ausnahme derjenigen, die innerhalb der oben angegebenen gesetzlichen Bestimmungen eingehen) unterliegen der Genehmigung von Ideallux. Fehler, die in den angegebenen physiologischen Mangel fallen und in keinem Fall 5% der gesamten installierten Artikel ausmachen, sind nicht von der 5-Jahres-Garantie abgedeckt. Allgemeine Garantiebedingungen sind verfügbar und können bei Ideallux angefordert werden

11. ERFÜLLUNGORT UND GERICHTSSTAND

Die Verträge, auch wenn sie mit ausländischen Staatsbürgern oder für im Ausland geliefertes Material vereinbart werden, werden durch den aktuellen italienischen Gesetzgeber geregelt. Das zuständige Gericht ist nur das am Sitz der Verkäuferfirma zuständige Gericht, ungeachtet der Artikel 32 und der nachfolgenden Zivilprozessordnung. Für den Käufer ist die Möglichkeit ausgeschlossen, sich an die Justizbehörde eines anderen Ortes auch als Garantie oder Verbindung der Sache zu wenden, erspart jedoch der Fähigkeit des verkaufenden Unternehmens, als Schauspielerin eine Klage am Wohnort in Italien durchzuführen oder im Ausland. Die eventuellen Reklamationen entbinden den Kunden nicht von der Einhaltung der vereinbarten Zahlungsbedingungen und bedeuten keine Verlängerung der vereinbarten Termine. Die Auftragskosten, ihre Registrierung und die eventuelle Transkription trägt der Kunde.

Catalogue **LOOKUP**

Graphics&Photo
Rosapinta&Partners

Contents
Ufficio tecnico | Ideallux®

LithoPrinter

The information and specifications are subject to changes without notice. Ideallux® reserves the right at any time at its discretion and without notice, to make changes to the products included in its catalogue. The technical data in the catalogue are valid except for errors and/or omissions. The reproduction of the material contained in this catalogue is prohibited without the written consent of Ideallux®.

GRUPPO  RAINA
Lookup

Via Casinghino, 11
27024 Cilavegna (PV) | Italy

Tel. +39 0381 969814
Fax +39 0381 669709

grupporaina@ideallux.it
www.grupporaina.it